

Integrity, innovation  
win-win, development

# Hi-Safe



## Lock body

# About Us

HI SAFE LOCKS WARE Hardware Co., Ltd. was founded in 1882 and is located in ALIGARH Town, UTTAR PRADESH, INDIA. It is a technology-driven enterprise specializing in the R&D, production, and sales of high-end lock bodies and CUSTOMIES HARDWARE SOLUTIONS has obtained ISO9001 Quality Management System certification. The company holds over 12 utility model patents and invention patents. With a production area of 5,000 square meters, it is equipped with professional R&D, quality control, and production teams.

The clean and tidy factory and office environment, along with a specialized and precise testing center, enable the company to support the lock AND HARDWARE industry with accelerated efficiency and superior service. HI SAFE Hardware has always adhered to the business philosophy of "Quality, Integrity, Innovation, Dedication, and Gratitude," continuously embracing creativity, strictly efficient services.

# Hi-Safe

## 85 European standard lock body series

# K4085

## European standard lock body

### Lock body parameter

- Door margin : 40mm
- Center distance : 85mm

### Liner parameter

- Type : Square head
- Metal material : SUS304 SUS201
- Thickness : 3mm
- Width : 22mm
- Length : 240mm

### Part parameter

- Oblique tongue : copper
- Square tongue : copper
- Square hole core : copper
- Shell : Fingerprint-resistant electrolytic plate 1.2mm

### Accessories

- Buckle plate : SUS304 SUS201
- Buckle box : PP
- Stainless steel screw



Product size

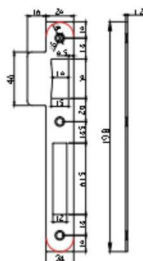
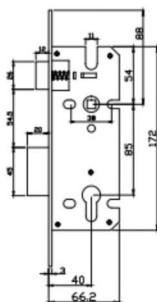

Gusset size

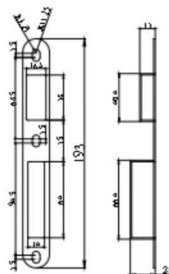

Buckle box size

\* Side panel: optional square and rounded corners

### K5572

#### European standard lock body

##### Lock body parameter

- Door margin : 55mm
- Center distance : 72mm

##### Liner parameter

- Type : Round head
- Metal material : SUS304 SUS201
- Thickness : 3mm
- Width : 20/22/24mm
- Length : 235mm

##### Part parameter

- Oblique tongue : Precision casting SUS304
- Square tongue : SUS304 Zinc alloy
- Square hole core : 8X8mm Stainless steel /Iron
- Shell : Fingerprint-resistant electrolytic plate 1.2/1.5mm

##### Accessories

- Buckle plate : SUS304 SUS201
- Buckle box : PP
- Stainless steel screw



### K5572

#### Cylindrical lock body

##### Lock body parameter

- Door margin : 55mm
- Center distance : 72mm

##### Liner parameter

- Type : Round head
- Metal material : SUS304 SUS201
- Thickness : 3mm
- Width : 24mm
- Length : 235mm

##### Part parameter

- Oblique tongue : SUS304
- Trident tongue : SUS304
- Square hole core : 8X8mm Stainless steel /Iron
- Shell : Fingerprint-resistant electrolytic plate 1.2mm

##### Accessories

- Buckle plate : SUS304 SUS201
- Buckle box : PP
- Stainless steel screw

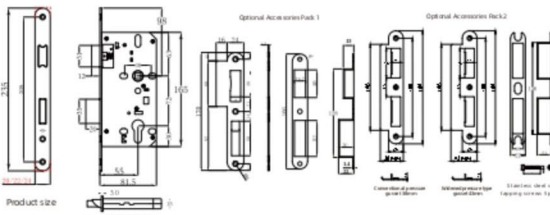

\* Side panel: optional square and rounded corners

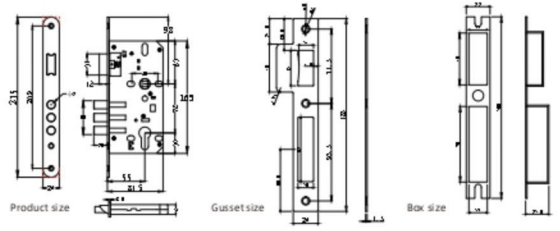

\* Side panel: optional square and rounded corners

### K5572

#### Mute lock body



##### Lock body parameter

- Door margin : 55mm
- Center distance : 72mm

##### Liner parameter

- Type : Round head
- Metal material : SUS304 SUS201
- Thickness : 2.5mm
- Width : 20/22/24mm
- Length : 235mm

##### Part parameter

- Oblique tongue : Zinc alloy
- Square tongue : Zinc alloy
- Square hole core : 8X8mm Stainless steel /Iron
- Shell : Fingerprint-resistant electrolytic plate 1.2mm

##### Accessories

- Buckle plate : SUS304 SUS201
- Buckle box : PP
- Stainless steel screw



### V5572

#### Mute lock body



##### Lock body parameter

- Door margin : 55mm
- Center distance : 72mm

##### Liner parameter

- Type : Round head
- Metal material : SUS304 SUS201
- Thickness : 2.5mm
- Width : 20/22/24mm
- Length : 235mm

##### Part parameter

- Oblique tongue : Zinc alloy
- Square tongue : Zinc alloy
- Square hole core : 8X8mm Stainless steel /Iron
- Shell : Fingerprint-resistant electrolytic plate 1.2/1.5mm

##### Accessories

- Buckle plate : SUS201
- Buckle box : PP
- Stainless steel screw

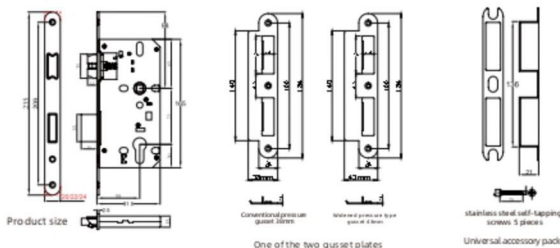

\* Side panel: optional square and rounded corners

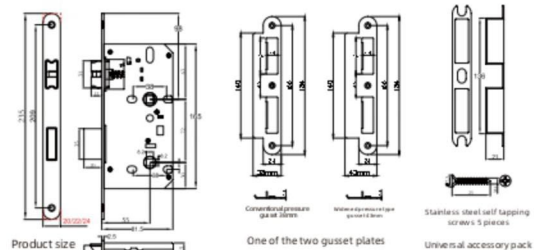

\* Side panel: optional square and rounded corners

### V5572

#### Blade lock body

##### Lock body parameter

- Door margin : 55mm
- Center distance : 72mm

##### Liner parameter

- Type : Round head
- Metal material : SUS304 SUS201
- Thickness : 2.5mm
- Width : 24mm
- Length : 235mm

##### Part parameter

- Oblique tongue : Zinc alloy
- Square tongue : Zinc alloy
- Square hole core : 8X8mm  
Stainless steel / Iron
- Shell : Fingerprint-resistant  
electrolytic plate  
1.2mm

##### Accessories

- Buckle plate : SUS304 SUS201
- Buckle box : PP
- Stainless steel screw

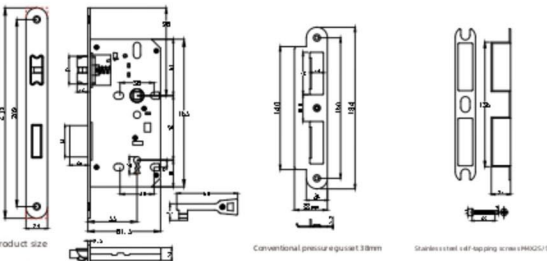

\* Side panel: optional square and rounded corners

### K5572

#### Blade lock body

##### Lock body parameter

- Door margin : 55mm
- Center distance : 72mm

##### Liner parameter

- Type : Square head
- Metal material : SUS304 SUS201
- Thickness : 2.5mm
- Width : 20/22/24mm
- Length : 235mm

##### Part parameter

- Oblique tongue : SUS304
- Square tongue : SUS304 SUS201
- Square hole core : 8X8mm  
Stainless steel / Iron
- Shell : Fingerprint-resistant  
electrolytic plate  
1.2mm

##### Accessories

- Buckle plate : SUS304 SUS201
- Buckle box : PP
- Stainless steel screw

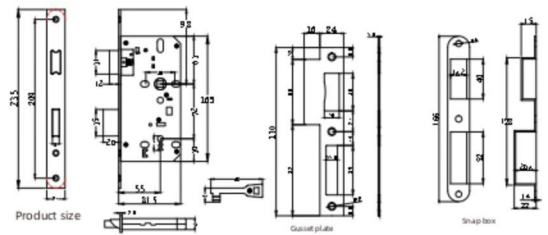

\* Side panel: optional square and rounded corners

### V5572

#### Mute lock body

##### Lock body parameter

- Door margin : 55mm
- Center distance : 72mm

##### Liner parameter

- Type : Round head
- Metal material : SUS304 SUS201
- Thickness : 2.5mm
- Width : 20/22/24mm
- Length : 235mm

##### Part parameter

- Oblique tongue : Zinc alloy
- Square tongue : Zinc alloy
- Square hole core : 8X8mm  
Stainless steel / Iron
- Shell : Fingerprint-resistant  
electrolytic plate  
1.2/1.5mm

##### Accessories

- Buckle plate : SUS304 SUS201
- Buckle box : PP
- Stainless steel screw

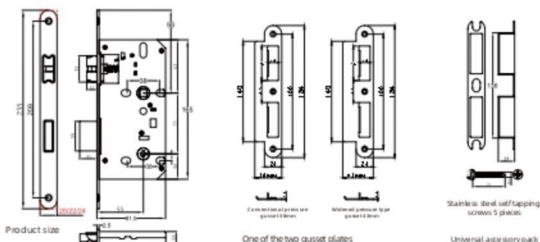

\* Side panel: optional square and rounded corners

### K5572

#### Touching ball lock body

##### Lock body parameter

- Door margin : 55mm
- Center distance : 72mm

##### Liner parameter

- Type : Square head
- Metal material : SUS304
- Thickness : 3mm
- Width : 24mm
- Length : 235mm

##### Part parameter

- Roller latch : SUS304
- Square tongue : SUS304
- Shell : Fingerprint-resistant  
electrolytic plate  
1.2/1.5mm

##### Accessories

- Buckle plate : SUS304
- Buckle box : PP
- Stainless steel screw

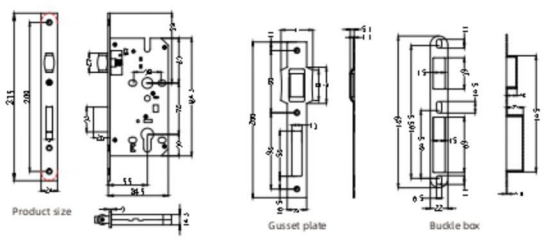

\* Side panel: optional square and rounded corners

### K5572

#### Single oblique tongue

##### Lock body parameter

- Door margin : 55mm
- Center distance : 72mm

##### Liner parameter

- Type : Square head
- Metal material : SUS304 SUS201
- Thickness : 3mm
- Width : 22mm
- Length : 235mm

##### Part parameter

- Oblique tongue : SUS304
- Square hole core : 8X8mm  
Stainless steel / Iron
- Shell : Fingerprint-resistant  
electrolytic plate  
1.2mm

##### Accessories

- Buckle plate : SUS304 SUS201
- Buckle box : PP
- Stainless steel screw

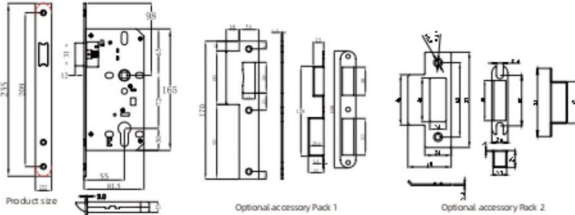

\* Side panel: optional square and rounded corners

### K5572

#### Single square tongue

##### Lock body parameter

- Door margin : 55mm
- Center distance : 72mm

##### Liner parameter

- Type : Square head
- Metal material : SUS304 SUS201
- Thickness/厚度 : 3mm
- Width/宽度 : 22mm
- Length/长度 : 235mm

##### Part parameter

- Square tongue : SUS304
- Shell : Fingerprint-resistant  
electrolytic plate  
1.2mm

##### Accessories

- Buckle plate : SUS304 SUS201
- Buckle box : PP
- Stainless steel screw

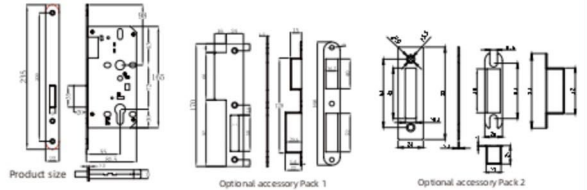

\* Side panel: optional square and rounded corners

### K5572H

#### Mute lock body

##### Lock body parameter

- Door margin : 55mm
- Center distance : 72mm

##### Liner parameter

- Type : Round head
- Metal material : SUS201
- Thickness : 3mm
- Width : 20mm
- Length : 235mm

##### Part parameter

- Oblique tongue : Zinc alloy
- Square tongue : Zinc alloy
- Square hole core : 8X8mm Iron
- Shell : Fingerprint-resistant  
electrolytic plate  
1.2mm

##### Accessories

- Buckle plate : SUS201
- Buckle box : PP
- Stainless steel screw

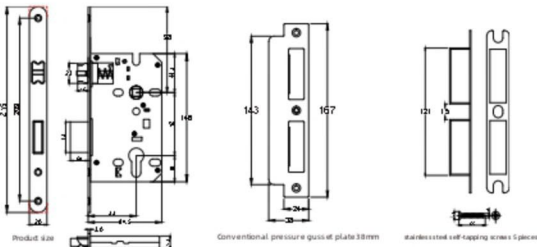
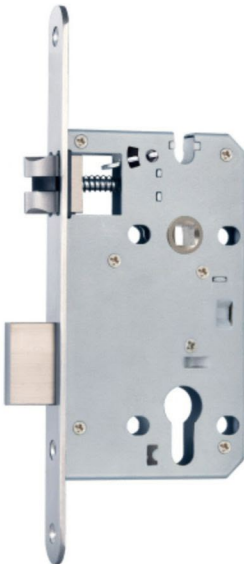

\* Side panel: optional square and rounded corners

### V5572H

#### Mute lock body

##### Lock body parameter

- Door margin : 55mm
- Center distance : 72mm

##### Liner parameter

- Type : Round head
- Metal material : SUS201
- Thickness : 3mm
- Width : 20mm
- Length : 235mm

##### Part parameter

- Oblique tongue : Zinc alloy
- Square tongue : Zinc alloy
- Square hole core : 8X8mm Iron
- Shell : Fingerprint-resistant  
electrolytic plate  
1.2mm

##### Accessories

- Buckle plate : SUS201
- Buckle box : PP
- Stainless steel screw

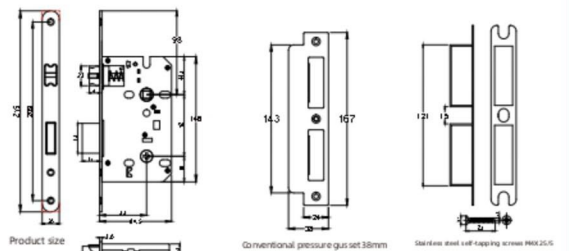

\* Side panel: optional square and rounded corners

### K6072

#### European standard lock body

##### Lock body parameter

- Door margin : 60mm
- Center distance : 72mm

##### Liner parameter

- Type : Square head
- Metal material : SUS304 SUS201
- Thickness : 3mm
- Width : 20/22/24mm
- Length : 235mm

##### Part parameter

- Oblique tongue : Precision casting SUS304
- Square tongue : SUS304 Zinc alloy
- Square hole core : 8X8mm Stainless steel /Iron
- Shell : Fingerprint-resistant electrolytic plate 1.2/1.5mm

##### Accessories

- Buckle plate : SUS304 SUS201
- Buckle box : PP
- Stainless steel screw



### K6072

#### Touching ball lock body

##### Lock body parameter

- Door margin : 60mm
- Center distance : 72mm

##### Liner parameter

- Type : Square head
- Metal material : SUS304
- Thickness : 3mm
- Width : 24mm
- Length : 235mm

##### Part parameter

- Roller latch : SUS304
- Square tongue : SUS304
- Shell : Fingerprint-resistant electrolytic plate 1.2mm

##### Accessories

- Buckle plate : SUS304
- Buckle box : PP
- Stainless steel screw

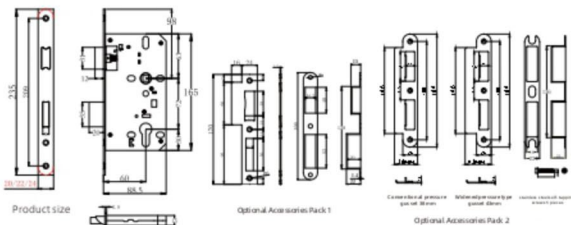

\* Side panel: optional square and rounded corners

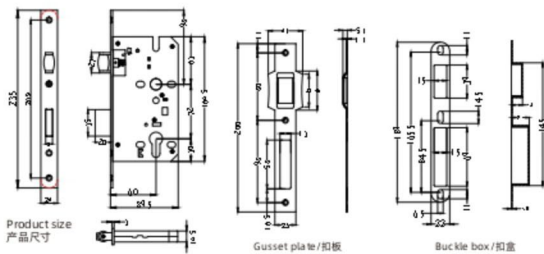

\* 衬板: 方角圆角可选 \* Side panel: optional square and rounded corners

### K7072Z

#### European standard lock body

##### Lock body parameter

- Door margin : 70mm
- Center distance : 72mm

##### Liner parameter

- Type : Square head
- Metal material : SUS304 SUS201
- Thickness : 3mm
- Width : 24mm
- Length : 235mm

##### Part parameter

- Oblique tongue : SUS304
- Square tongue : SUS304 SUS201
- Square hole core : SUS304
- Shell : Fingerprint-resistant electrolytic plate 1.2/1.5mm

##### Accessories

- Buckle plate : SUS304
- Buckle box : PP
- Stainless steel screw

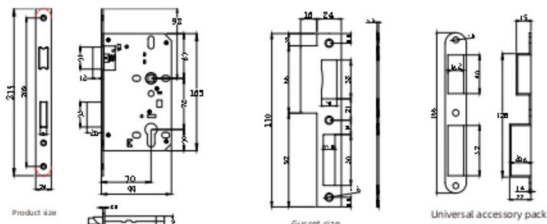

\* Side panel: optional square and rounded corners

### K8072Z

#### European standard lock body

##### Lock body parameter

- Door margin : 80mm
- Center distance : 72mm

##### Liner parameter

- Type : Square head
- Metal material : SUS304 SUS201
- Thickness : 3mm
- Width : 24mm
- Length : 235mm

##### Part parameter

- Oblique tongue : SUS304
- Square tongue : SUS304 SUS201
- Square hole core : SUS304
- Shell : Fingerprint-resistant electrolytic plate 1.2/1.5mm

##### Accessories

- Buckle plate : SUS304
- Buckle box : PP
- Stainless steel screw

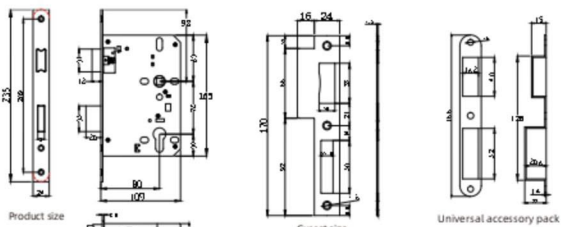

\* Side panel: optional square and rounded corners

# Hi-Safe

## 85 European standard lock body series

# K4085

## European standard lock body

### Lock body parameter

- Door margin : 40mm
- Center distance : 85mm

### Liner parameter

- Type : Square head
- Metal material : SUS304 SUS201
- Thickness : 3mm
- Width : 22mm
- Length : 240mm

### Part parameter

- Oblique tongue : copper
- Square tongue : copper
- Square hole core : copper

- Shell : Fingerprint-resistant electrolytic plate 1.2mm

### Accessories

- Buckle plate : SUS304 SUS201
- Buckle box : PP
- Stainless steel screw



Product size

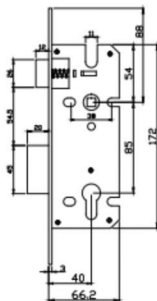

Gusset size

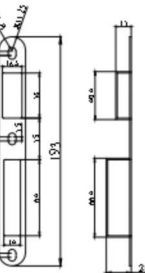
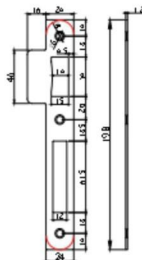

Buckle box size

\* Side panel: optional square and rounded corners

### K4585

#### European standard lock body

##### Lock body parameter

- Door margin : 45mm
- Center distance : 85mm

##### Liner parameter

- Type : Square head
- Metal material : SUS304 SUS201
- Thickness : 3mm
- Width : 22mm
- Length : 240mm

##### Part parameter

- Oblique tongue : SUS304 Zinc alloy
- Square tongue : SUS304 Zinc alloy
- Square hole core : 8x8mm Stainless steel /Iron
- Shell : 1.2mm Stainless iron430 Fingerprint-resistant electrolytic plate 1.2mm

##### Accessories

- Buckle plate : SUS304 SUS201
- Buckle box : PP
- Stainless steel screw



### K4585

#### Trident tongue lock body

##### Lock body parameter

- Door margin : 45mm
- Center distance : 85mm

##### Liner parameter

- Type : Square head
- Metal material : SUS201
- Thickness : 3mm
- Width : 22mm
- Length : 240mm

##### Part parameter

- Oblique tongue : Zinc alloy
- Trident tongue : Zinc alloy
- Square hole core : Iron
- Shell : Fingerprint-resistant electrolytic plate 1.2mm

##### Accessories

- Buckle plate : SUS201
- Buckle box : PP
- Stainless steel screw

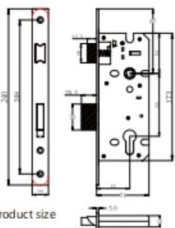

Product size

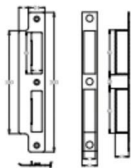

Optional Accessories Pack 1

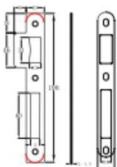

Optional Accessories Pack 2

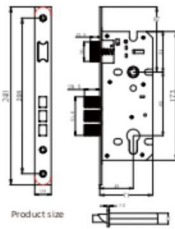

Product size

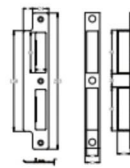

Optional Accessories Pack 1

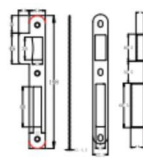

Optional Accessories Pack 2

\* Side panel: optional square and rounded corners

\* Side panel: optional square and rounded corners

### K4585

#### Touching ball lock body

##### Lock body parameter

- Door margin : 45mm
- Center distance : 85mm

##### Liner parameter

- Type : Square head
- Metal material : SUS304
- Thickness : 3mm
- Width : 22/24mm
- Length : 240mm

##### Part parameter

- Roller latch : SUS304
- Square tongue : SUS304
- Shell : Fingerprint-resistant electrolytic plate 1.2/1.5mm

##### Accessories

- Buckle plate : SUS304 SUS201
- Buckle box : PP
- Stainless steel screw



### K4585

#### Mute lock body

##### Lock body parameter

- Door margin : 45mm
- Center distance : 85mm

##### Liner parameter

- Type : Square head
- Metal material : SUS304 SUS201
- Thickness : 3mm
- Width : 22mm
- Length : 240mm

##### Part parameter

- Oblique tongue : Zinc alloy
- Square tongue : Zinc alloy
- Square hole core : 8x8mm Stainless steel /Iron
- Shell : 1.2mm Stainless iron430 Fingerprint-resistant electrolytic plate 1.2mm

##### Accessories

- Buckle plate : SUS304 SUS201
- Buckle box : PP
- Stainless steel screw



Product size

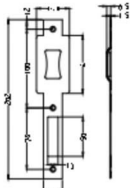

Gusset plate

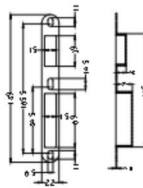

Buckle box

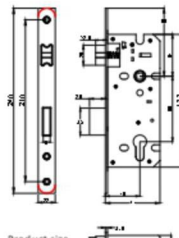

Product size

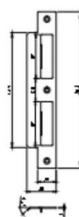

Gusset plate

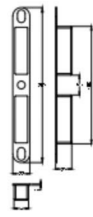

Buckle box

\* Side panel: optional square and rounded corners

\* Side panel: optional square and rounded corners

### K5085

#### European standard lock body

##### Lock body parameter

- Door margin : 50mm
- Center distance : 85mm

##### Liner parameter

- Type : Square head
- Metal material : SUS304 SUS201
- Thickness : 3mm
- Width : 22mm
- Length : 240mm

##### Part parameter

- Oblique tongue : SUS304 Zinc alloy
- Square tongue : SUS304 Zinc alloy
- Square hole core : 8X8mm Stainless steel /Iron
- Shell : Fingerprint-resistant electrolytic plate 1.2/1.5mm

##### Accessories

- Buckle plate : SUS304 SUS201
- Buckle box : PP
- Stainless steel screw



### K5085

#### Trident tongue lock body

##### Lock body parameter

- Door margin : 50mm
- Center distance : 85mm

##### Liner parameter

- Type : Square head
- Metal material : SUS201
- Thickness : 3mm
- Width : 22mm
- Length : 240mm

##### Part parameter

- Oblique tongue : Zinc alloy
- Trident tongue : Zinc alloy
- Square hole core : Iron
- Shell : Fingerprint-resistant electrolytic plate 1.2/1.5mm

##### Accessories

- Buckle plate : SUS201
- Buckle box : PP
- Stainless steel screw

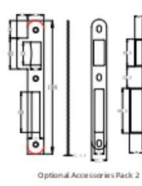
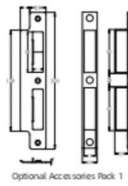
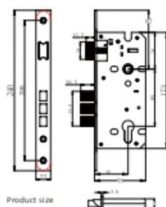
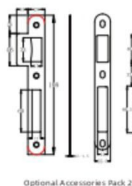
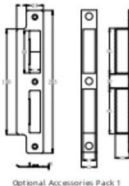

\* Side panel: optional square and rounded corners

\* Side panel: optional square and rounded corners

### K5085

#### Touching ball lock body

##### Lock body parameter

- Door margin : 50mm
- Center distance : 85mm

##### Liner parameter

- Type : Square head
- Metal material : SUS304
- Thickness : 3mm
- Width : 22/24mm
- Length : 240mm

##### Part parameter

- Roller latch : SUS304
- Square tongue : SUS304
- Shell : Fingerprint-resistant electrolytic plate 1.2mm

##### Accessories

- Buckle plate : SUS304
- Buckle box : PP
- Stainless steel screw



### K5085

#### Mute lock body

##### Lock body parameter

- Door margin : 50mm
- Center distance : 85mm

##### Liner parameter

- Type : Square head
- Metal material : SUS304 SUS201
- Thickness : 3mm
- Width : 22mm
- Length : 240mm

##### Part parameter

- Oblique tongue : Zinc alloy
- Square tongue : Zinc alloy
- Square hole core : 8X8mm Stainless steel /Iron
- Shell : Fingerprint-resistant electrolytic plate 1.2/1.5mm

##### Accessories

- Buckle plate : SUS304 SUS201
- Buckle box : PP
- Stainless steel screw

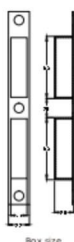
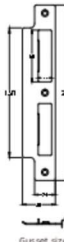
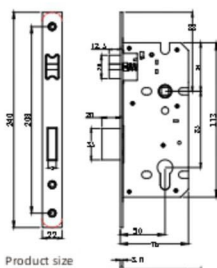
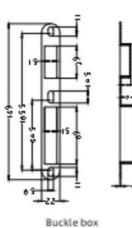
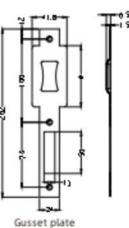

\* Side panel: optional square and rounded corners

\* Side panel: optional square and rounded corners

### K6085

#### European standard lock body

##### Lock body parameter

- Door margin : 60mm
- Center distance : 85mm

##### Liner parameter

- Type : Square head
- Metal material : SUS304 SUS201
- Thickness : 3mm
- Width : 22mm
- Length : 240mm

##### Part parameter

- Oblique tongue : SUS304 Zinc alloy
- Square tongue : SUS304 Zinc alloy
- Square hole core : 8X8mm Stainless steel /Iron
- Shell : Fingerprint-resistant electrolytic plate 1.2mm

##### Accessories

- Buckle plate : SUS304 SUS201
- Buckle box : PP
- Stainless steel screw

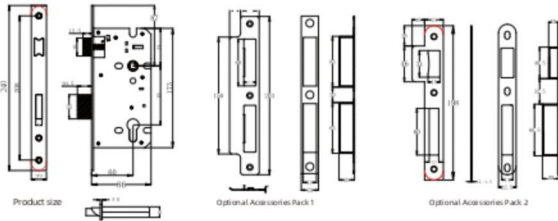

\* Side panel: optional square and rounded corners

### K6085

#### Trident tongue lock body

##### Lock body parameter

- Door margin : 60mm
- Center distance : 85mm

##### Liner parameter

- Type : Square head
- Metal material : SUS201
- Thickness : 3mm
- Width : 22mm
- Length : 240mm

##### Part parameter

- oblique tongue : Zinc alloy
- Trident tongue : Zinc alloy
- Square hole core : Iron
- Shell : Fingerprint-resistant electrolytic plate 1.2mm

##### Accessories

- Buckle plate : SUS201
- Buckle box : PP
- Stainless steel screw

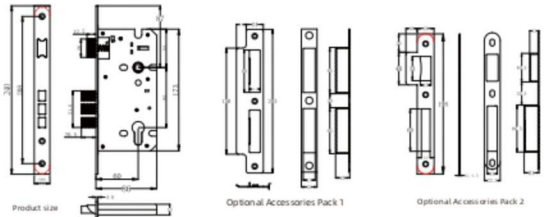

\* Side panel: optional square and rounded corners

### K6085

#### Touching ball lock body

##### Lock body parameter

- Door margin : 60mm
- Center distance : 85mm

##### Liner parameter

- Type : Square head
- Metal material : SUS304
- Thickness : 3mm
- Width : 22/24mm
- Length : 240mm

##### Part parameter

- Roller latch : SUS304
- Trident tongue : SUS304
- Shell : Fingerprint-resistant electrolytic plate 1.2mm

##### Accessories

- Buckle plate : SUS304
- Buckle box : PP
- Stainless steel screw

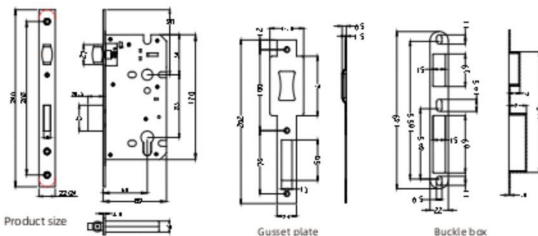

\* Side panel: optional square and rounded corners

### K6085

#### Mute lock body

##### Lock body parameter

- Door margin : 60mm
- Center distance : 85mm

##### Liner parameter

- Type : Square head
- Metal material : SUS304 SUS201
- Thickness : 3mm
- Width : 22mm
- Length : 240mm

##### Part parameter

- Oblique tongue : Zinc alloy
- Square tongue : Zinc alloy
- Square hole core : 8X8mm Stainless steel /Iron
- Shell : Fingerprint-resistant electrolytic plate 1.2mm

##### Accessories

- Buckle plate : SUS304 SUS201
- Buckle box : PP
- Stainless steel screw

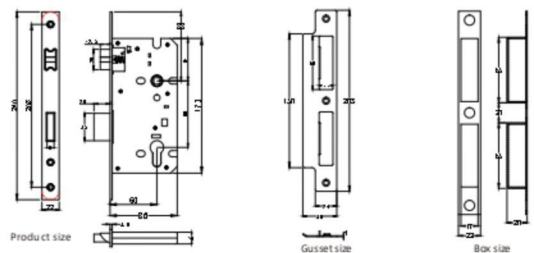

\* Side panel: optional square and rounded corners

### K6085

#### Cylindrical lock body

##### Lock body parameter

- Door margin : 60mm
- Center distance : 85mm

##### Liner parameter

- Type : Round head
- Metal material : SUS304 SUS201
- Thickness : 3mm
- Width : 22mm
- Length : 240mm

##### Part parameter

- Oblique tongue : SUS304
- Trident tongue : SUS304
- Square hole core : 8X8mm  
Stainless steel /Iron
- Shell : Fingerprint-resistant  
electrolytic plate  
1.2mm

##### Accessories

- Buckle plate : SUS304 SUS201
- Buckle box : PP
- Stainless steel screw

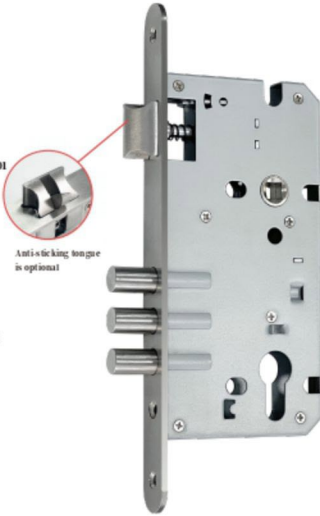

Anti-ticking tongue is optional

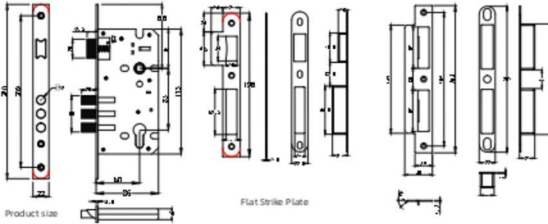

Product size

Flat Strike Plate

Profiled Strike Plate

\* Side panel: optional square and rounded corners

### K6085

#### Cylindrical lock body

##### Lock body parameter

- Door margin : 60mm
- Center distance : 85mm

##### Liner parameter

- Type : Round head
- Metal material : SUS304 SUS201
- Thickness : 3mm
- Width : 22mm
- Length : 240mm

##### Part parameter

- Oblique tongue : SUS304
- Trident tongue : SUS304
- Square hole core : 8X8mm  
Stainless steel /Iron
- Shell : Fingerprint-resistant  
electrolytic plate  
1.2mm

##### Accessories

- Buckle plate : SUS304 SUS201
- Buckle box : PP
- Stainless steel screw



Anti-ticking tongue is optional

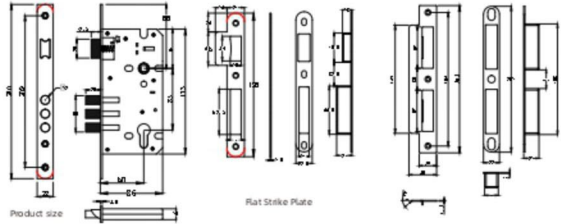

Product size

Flat Strike Plate

Profiled Strike Plate

\* Side panel: optional square and rounded corners

### K6085

#### European standard lock body

##### Lock body parameter

- Door margin : 60mm
- Center distance : 85mm

##### Liner parameter

- Type : Square head
- Metal material : SUS304 SUS201
- Thickness : 3mm
- Width : 20/22/24mm
- Length : 240mm

##### Part parameter

- Oblique tongue : Precision casting  
SUS304
- Square tongue : SUS304 Zinc alloy
- Square hole core : 8X8mm  
Stainless steel /Iron
- Shell : Fingerprint-resistant  
electrolytic plate  
1.2/1.5mm

##### Accessories

- Buckle plate : SUS304 SUS201
- Buckle box : PP
- Stainless steel screw

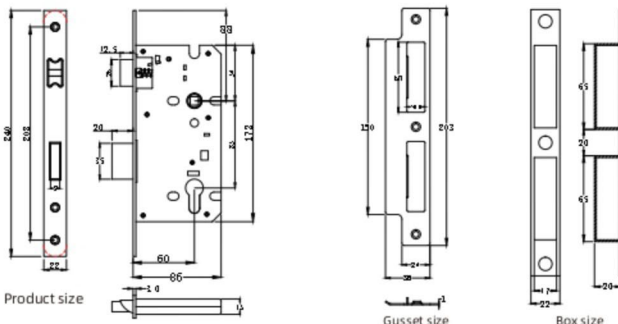

Product size

Gusset size

Box size

\* Side panel: optional square and rounded corners

### K6085

#### Escape lock body

##### Lock body parameter

- Door margin : 60mm
- Center distance : 85mm

##### Liner parameter

- Type : Square head
- Metal material : SUS304/SUS201
- Thickness : 3mm
- Width : 22mm
- Length : 240mm

##### Part parameter

- Oblique tongue : SUS304
- Square tongue : SUS304
- Square hole core : 8X8mm  
Stainless steel  
Iron
- Shell : Fingerprint-resistant  
electrolytic plate  
1.2mm

##### Accessories

- Buckle plate : SUS304/SUS201
- Buckle box : PP
- Stainless steel screw

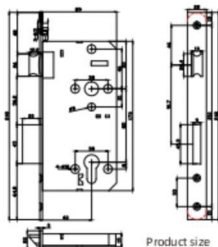

Product size

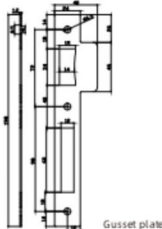

Gusset plate

### K7085

#### Copper monosyllabic lock body

##### Lock body parameter

- Door margin : 70mm
- Center distance : 85mm

##### Liner parameter

- Type : Square head
- Metal material : SUS304/SUS201
- Thickness : 3mm
- Width : 22mm
- Length : 240mm

##### Part parameter

- Oblique tongue : copper
- Square tongue : copper
- Square hole core : copper
- Shell : Fingerprint-resistant  
electrolytic plate  
1.2mm

##### Accessories

- Buckle plate : SUS304/SUS201
- Buckle box : PP
- Stainless steel screw

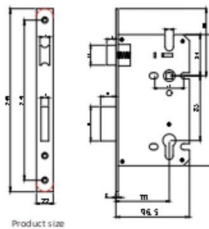

Product size

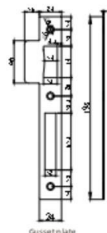

Gusset plate

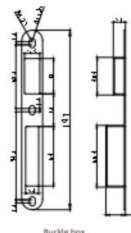

Buckle box

# Hi-Safe

## European standard lock body series

### K5578Z

#### European standard lock body

##### Lock body parameter

- Door margin : 55mm
- Center distance : 78mm

##### Liner parameter

- Type : Square head
- Metal material : SUS304 SUS201
- Thickness : 3mm
- Width : 24mm
- Length : 235mm

##### Part parameter

- Oblique tongue : SUS304
- Square tongue : SUS304 SUS201
- Square hole core : SUS304
- Shell : Fingerprint-resistant electrolytic plate 1.2/1.5mm

##### Accessories

- Buckle plate : SUS304 SUS201
- Buckle box : PP
- Stainless steel screw

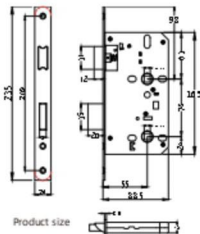

Product size

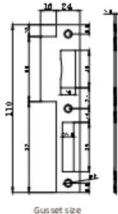

Gusset size

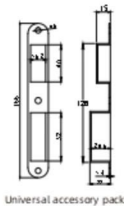

Universal accessory pack

### K6078Z

#### European standard lock body

##### Lock body parameter

- Door margin : 60mm
- Center distance : 78mm

##### Liner parameter

- Type : Square head
- Metal material : SUS304 SUS201
- Thickness : 3mm
- Width : 24mm
- Length : 235mm

##### Part parameter

- Oblique tongue : SUS304
- Square tongue : SUS304 SUS201
- Square hole core : SUS304
- Shell : Fingerprint-resistant electrolytic plate 1.2/1.5mm

##### Accessories

- Buckle plate : SUS304
- Buckle box : PP
- Stainless steel screw

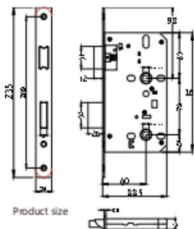

Product size

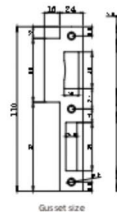

Gusset size

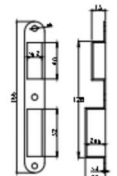

Universal accessory pack

\* Side panel: optional square and rounded corners

\* Side panel: optional square and rounded corners

### K2585

#### Extremely narrow lock body

##### Lock body parameter

- Door margin : 25mm
- Center distance : 85mm

##### Liner parameter

- Type : Square head
- Metal material : SUS304 SUS201
- Thickness : 3mm
- Width : 22mm
- Length : 240mm

##### Part parameter

- Oblique tongue : copper
- Square tongue : copper
- Square hole core : copper
- Shell : Fingerprint-resistant electrolytic plate 1.2mm

##### Accessories

- Buckle plate : SUS304 SUS201
- Buckle box : PP
- Stainless steel screw

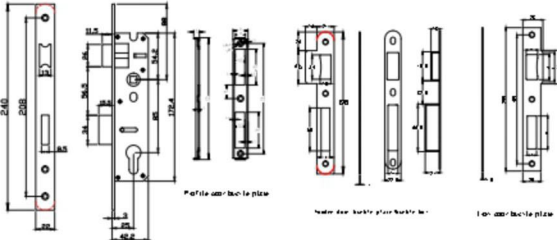

Product size

\* Side panel: optional square and rounded corners

### K3085

#### Extremely narrow lock body

##### Lock body parameter

- Door margin : 30mm
- Center distance : 85mm

##### Liner parameter

- Type : Square head
- Metal material : SUS304 SUS201
- Thickness : 2.5mm
- Width : 22mm
- Length : 240mm

##### Part parameter

- Oblique tongue : SUS304
- Square tongue : SUS304
- Square hole core : Iron
- Shell : Stainless steel casing

##### Accessories

- Buckle plate : SUS304 SUS201
- Buckle box : PP
- Stainless steel screw



Anti-sticking tongue is optional

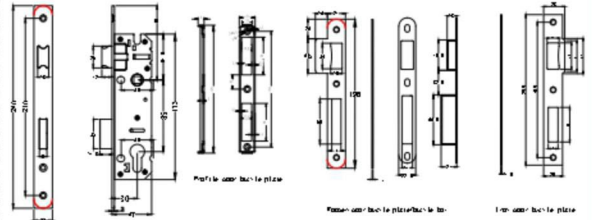

Product size

\* Side panel: optional square and rounded corners

### K3585

#### Extremely narrow lock body

##### Lock body parameter

- Door margin : 35mm
- Center distance : 85mm

##### Liner parameter

- Type : Square head
- Metal material : SUS304 SUS201
- Thickness : 2.5mm
- Width : 22mm
- Length : 240mm

##### Part parameter

- Oblique tongue : SUS304
- Square tongue : SUS304
- Square hole core : Iron
- Shell : Stainless steel casing

##### Accessories

- Buckle plate : SUS304 SUS201
- Buckle box : PP
- Stainless steel screw



Anti-sticking tongue is optional

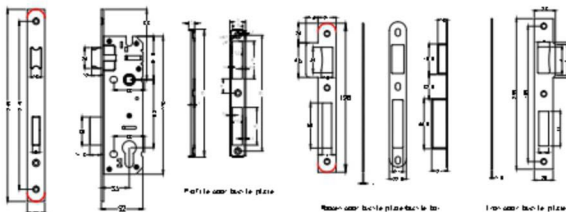

Product size

\* Side panel: optional square and rounded corners

### K4085

#### Extremely narrow lock body

##### Lock body parameter

- Door margin : 40mm
- Center distance : 85mm

##### Liner parameter

- Type : Square head
- Metal material : SUS304 SUS201
- Thickness : 2.5mm
- Width : 22mm
- Length : 240mm

##### Part parameter

- Oblique tongue : SUS304
- Square tongue : SUS304
- Square hole core : Iron
- Shell : Stainless steel casing

##### Accessories

- Buckle plate : SUS304 SUS201
- Buckle box : PP
- Stainless steel screw



Anti-sticking tongue is optional

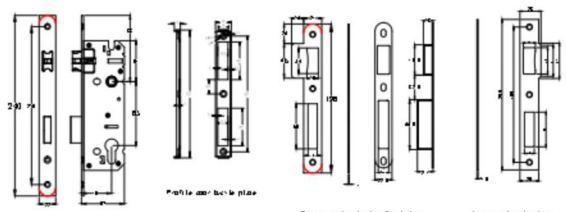

Product size

\* Side panel: optional square and rounded corners

# Hi-Safe

## 2585 — 4085 optional buckle plate

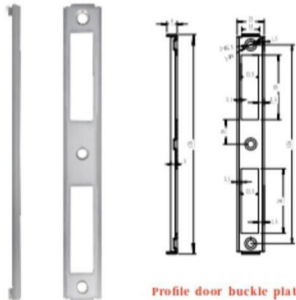

Profile door buckle plate

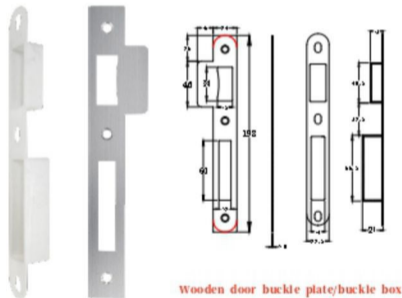

Wooden door buckle plate/buckle box

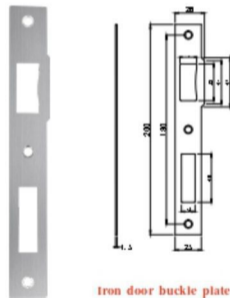

Iron door buckle plate

### KD5085-1

#### Four-column lock body

##### Lock body parameter

- Door margin : 50mm
- Center distance : 85mm

##### Liner parameter

- Type : Square head
- Metal material : SUS304 SUS201
- Thickness : 3mm
- Width : 24mm
- Length : 240mm

##### Part parameter

- Oblique tongue : SUS304 Zinc alloy
- Round tongue : SUS304 Zinc alloy
- Square hole core : 8X8mm Precision casting SUS304 Iron
- Shell : Fingerprint-resistant electrolytic plate 1.2mm

##### Accessories

- Buckle plate : SUS304 SUS201
- Buckle box : PP
- Stainless steel screw



### KD5085-A2

#### Four-column lock body

##### Lock body parameter

- Door margin : 50mm
- Center distance : 85mm

##### Liner parameter

- Type : Square head
- Metal material : SUS304 SUS201
- Thickness : 3mm
- Width : 24mm
- Length : 270mm

##### Part parameter

- Oblique tongue : SUS304 Zinc alloy
- Round tongue : SUS304 Zinc alloy
- Square hole core : copper
- Shell : Fingerprint-resistant electrolytic plate 1.2mm

##### Accessories

- Buckle plate : SUS304 SUS201
- Buckle box : PP
- Stainless steel screw

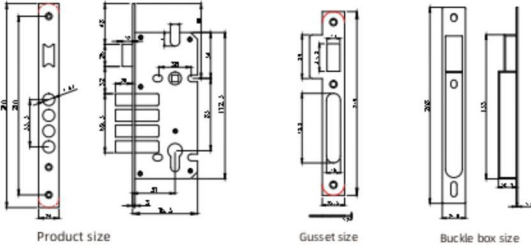

Product size

Gusset size

Buckle box size

\* Side panel: optional square and rounded corners

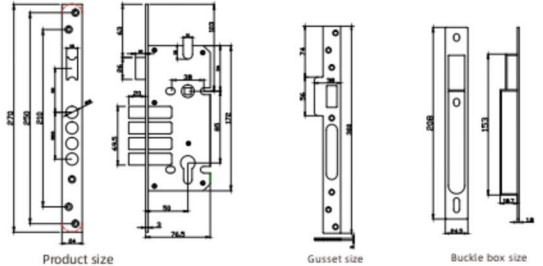

Product size

Gusset size

Buckle box size

\* Side panel: optional square and rounded corners

### KD6085(240mm)

#### Four-column lock body

##### Lock body parameter

- Door margin : 60mm
- Center distance : 85mm

##### Liner parameter

- Type : Square head
- Metal material : SUS304 SUS201
- Thickness : 3mm
- Width : 24mm
- Length : 240mm

##### Part parameter

- Oblique tongue : SUS304
- Round tongue : SUS304 / iron
- Square hole core : SUS304 / iron
- Shell : high carbon steel

##### Accessories

- Buckle plate : SUS304 SUS201
- Buckle box : PP
- Stainless steel screw

Anti-sticking tongue is optional

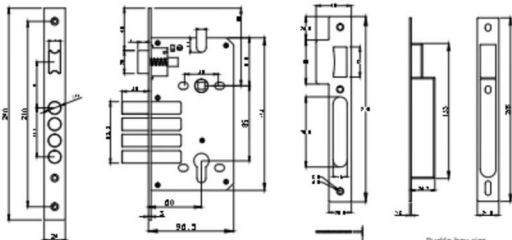

Product size

Gusset size

Buckle box size

### KD6085(270mm)

#### Four-column lock body

##### Lock body parameter

- Door margin : 60mm
- Center distance : 85mm

##### Liner parameter

- Type : Square head
- Metal material : SUS304 SUS201
- Thickness : 3mm
- Width : 24mm
- Length : 270mm

##### Part parameter

- Oblique tongue : SUS304
- Round tongue : SUS304 / iron
- Square hole core : SUS304 / iron
- Shell : high carbon steel

##### Accessories

- Buckle plate : SUS304 SUS201
- Buckle box : PP
- Stainless steel screw

Anti-sticking tongue is optional

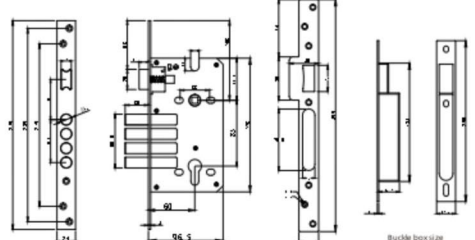

Product size

Gusset size

Buckle box size

### KDL-6085

#### Integrated lock

##### Lock body parameter

- Door margin : 60mm
- Center distance : 85mm

##### Liner parameter

- Type : Square head
- Metal material: SUS304
- Thickness : 3mm
- Width : 24mm
- Length : 620mm

##### Part parameter

- Oblique tongue : SUS304
- Round tongue : SUS304
- Square hole core : SUS304
- Shell : high carbon steel

##### Accessories

- Buckle plate : SUS304
- Stainless steel screw

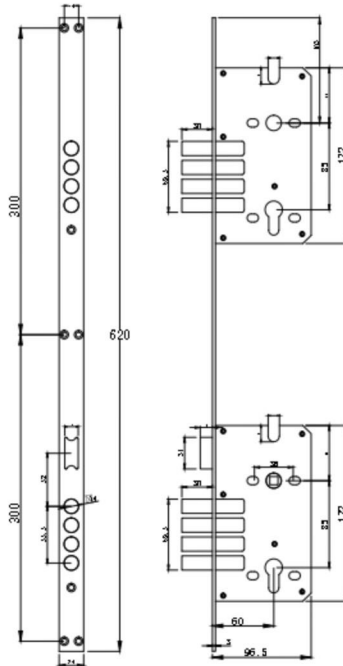

Product size



### GD6068

#### Four square tongue lock body

##### Lock body parameter

- Door margin : 60mm
- Center distance : 68mm

##### Liner parameter

- Type : Square head
- Metal material : SUS201
- Thickness : 3mm
- Width : 22mm
- Length : 260mm

##### Part parameter

- Oblique tongue : SUS304
- Square tongue : copper Zinc alloy
- Square hole core : copper
- Shell : SUS201

##### Accessories

- Buckle plate : SUS201
- Buckle box : PP
- Stainless steel screw

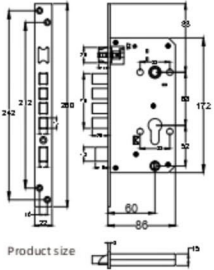

Product size

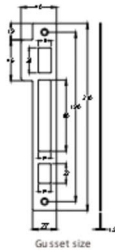

Gusset size



Buckle box size

### GD6068

#### Cylinder lock body

##### Lock body parameter

- Door margin : 60mm
- Center distance : 68mm

##### Liner parameter

- Type : Square head
- Metal material : SUS201
- Thickness : 3mm
- Width : 22mm
- Length : 260mm

##### Part parameter

- Oblique tongue : SUS304
- Round tongue : SUS201
- Square hole core : copper
- Shell : SUS201

##### Accessories

- Buckle plate : SUS201
- Buckle box : PP
- Stainless steel screw

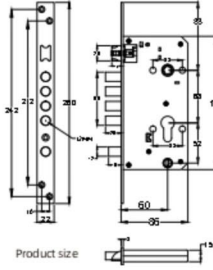

Product size

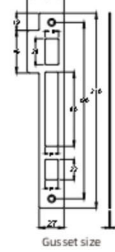

Gusset size

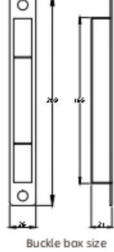

Buckle box size

### GD6068

#### Four square tongue lock body

##### Lock body parameter

- Door margin : 60mm
- Center distance : 68mm

##### Liner parameter

- Type : Square head
- Metal material : SUS201
- Thickness : 3mm
- Width : 22mm
- Length : 260mm

##### Part parameter

- Oblique tongue : SUS304
- Square tongue : copper Zinc alloy
- Square hole core : copper
- Shell : SUS201

##### Accessories

- Buckle plate : SUS201
- Buckle box : PP
- Stainless steel screw

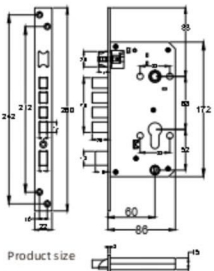

Product size

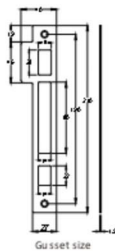

Gusset size



Buckle box size

### GD6068

#### Cylinder lock body

##### Lock body parameter

- Door margin : 60mm
- Center distance : 68mm

##### Liner parameter

- Type : Square head
- Metal material : SUS201
- Thickness : 3mm
- Width : 22mm
- Length : 260mm

##### Part parameter

- Oblique tongue : SUS304
- Round tongue : SUS201
- Square hole core : copper
- Shell : SUS201

##### Accessories

- Buckle plate : SUS201
- Buckle box : PP
- Stainless steel screw

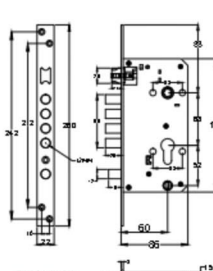

Product size

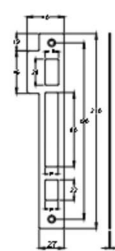

Gusset size

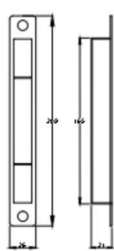

Buckle box size

### V4583

#### Escape lock body

##### Lock body parameter

- Door margin : 45mm
- Center distance : 83mm

##### Liner parameter

- Type : Round head
- Metal material : SUS201
- Thickness : 2.5mm
- Width : 22mm
- Length : 195mm

##### Part parameter

- Oblique tongue : Zinc alloy
- Square tongue : Zinc alloy
- Square hole core : 8X8mm Three sheet zinc alloy
- Shell : Cold plate+Popcorn

##### Accessories

- Buckle plate : SUS201
- Buckle box : PP
- Stainless steel screw

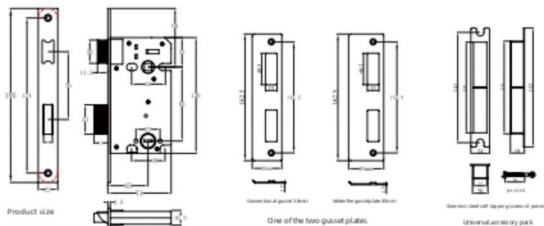

\* Side panel: optional square and rounded corners

### V5583

#### Escape lock body

##### Lock body parameter

- Door margin : 55mm
- Center distance : 83mm

##### Liner parameter

- Type : Square head
- Metal material : SUS304 SUS201
- Thickness : 2.5mm
- Width : 22/24mm
- Length : 195mm

##### Part parameter

- Oblique tongue : Zinc alloy
- Square tongue : Zinc alloy
- Square hole core : 8X8mm Three sheet zinc alloy
- Shell : Cold plate+Black lacquer

##### Accessories

- Buckle plate : SUS304 SUS201
- Buckle box : PP
- Stainless steel screw

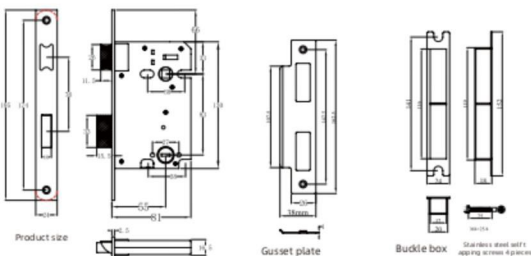

\* Side panel: optional square and rounded corners

### V5050

#### Mute lock body

##### Lock body parameter

- Door margin : 50mm
- Center distance : 50mm

##### Liner parameter

- Type : Square head
- Metal material : SUS304 SUS201
- Thickness : 2.5mm
- Width : 22mm
- Length : 147mm

##### Part parameter

- Oblique tongue : Zinc alloy
- Square tongue : Zinc alloy
- Square hole core : 8X8mm Iron
- Shell : Fingerprint-resistant electrolytic plate 1.2mm

##### Accessories

- Buckle plate : SUS304 SUS201
- Buckle box : PP
- Stainless steel screw



### V5050

#### Common lock body

##### Lock body parameter

- Door margin : 50mm
- Center distance : 50mm

##### Liner parameter

- Type : Square head
- Metal material : SUS304 SUS201
- Thickness : 2.5mm
- Width : 22mm
- Length : 147mm

##### Part parameter

- Oblique tongue : SUS304 Zinc alloy
- Square tongue : SUS304 Zinc alloy
- Square hole core : 8X8mm Precision casting SUS304 Iron
- Shell : Fingerprint-resistant electrolytic plate 1.2mm

##### Accessories

- Buckle plate : SUS304 SUS201
- Buckle box : PP
- Stainless steel screw

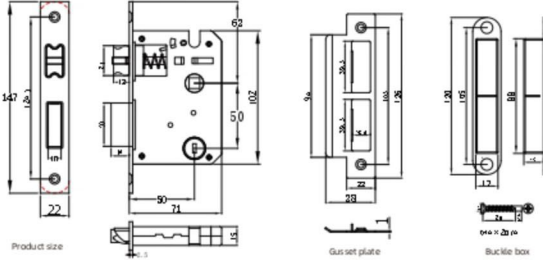

\* Side panel: optional square and rounded corners

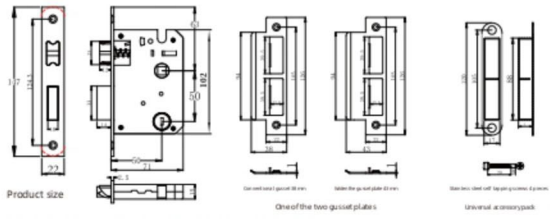

\* Side panel: optional square and rounded corners

## V5050

### Anti insertion lock body

##### Lock body parameter

- Door margin : 50mm
- Center distance : 50mm

##### Liner parameter

- Type : Square head
- Metal material : SUS304 SUS201
- Thickness : 2.5mm
- Width : 22mm
- Length : 147mm

##### Part parameter

- Oblique tongue : Zinc alloy
- Square tongue : Zinc alloy
- Square hole core : 8X8mm Iron
- Shell : Fingerprint-resistant electrolytic plate 1.2mm

##### Accessories

- Buckle plate : SUS304 SUS201
- Buckle box : PP
- Stainless steel screw

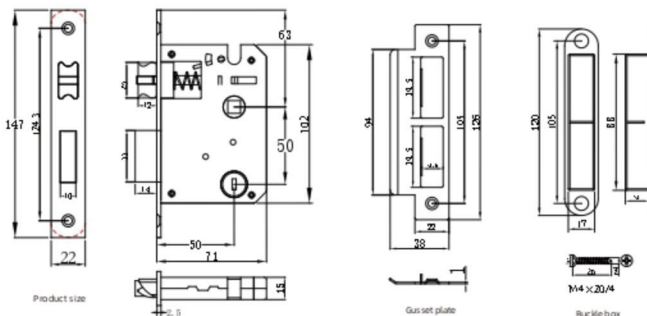

\* Side panel: optional square and rounded corners



### K4558

#### Anti insertion lock body

##### Lock body parameter

- Door margin : 45mm
- Center distance : 58mm

##### Liner parameter

- Type : Square head
- Metal material : SUS304 SUS201
- Thickness : 2.5mm
- Width : 22mm
- Length : 170mm

##### Part parameter

- Oblique tongue : SUS304
- Square tongue : SUS304
- Square hole core : 8X8mm Iron
- Shell : 430 stainless steel

##### Accessories

- Buckle plate : SUS304 SUS201
- Buckle box : PP
- Stainless steel screw

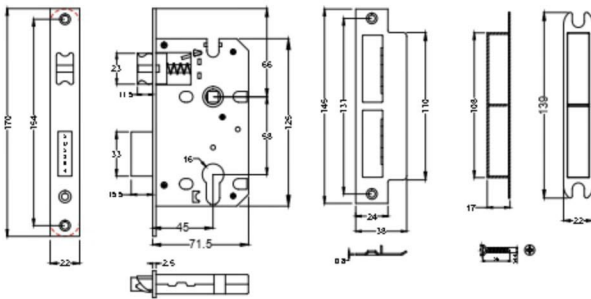

\* Side panel: optional square and rounded corners

### K4558H

#### Mute lock body

##### Lock body parameter

- Door margin : 45mm
- Center distance : 58mm

##### Liner parameter

- Type : Square head
- Metal material : SUS201
- Thickness : 2.5mm
- Width : 22mm
- Length : 170mm

##### Part parameter

- Oblique tongue : Zinc alloy
- Square tongue : Zinc alloy
- Square hole core : 8X8mm Iron
- Shell : Fingerprint-resistant electrolytic plate 1.2mm

##### Accessories

- Buckle plate : SUS201
- Buckle box : PP
- Stainless steel screw

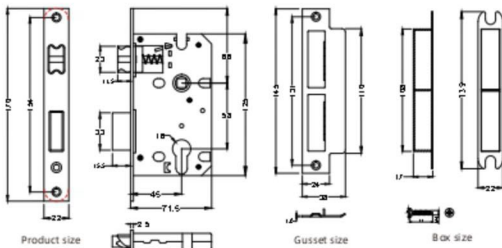

\* Side panel: optional square and rounded corners

### V4558H

#### Mute lock body

##### Lock body parameter

- Door margin : 45mm
- Center distance : 58mm

##### Liner parameter

- Type : Square head
- Metal material : SUS201
- Thickness : 2.5mm
- Width : 23mm
- Length : 170mm

##### Part parameter

- Oblique tongue : Zinc alloy
- Square tongue : Zinc alloy
- Square hole core : 8X8mm Iron
- Shell : Fingerprint-resistant electrolytic plate 1.2mm

##### Accessories

- Buckle plate : SUS201
- Buckle box : PP
- Stainless steel screw

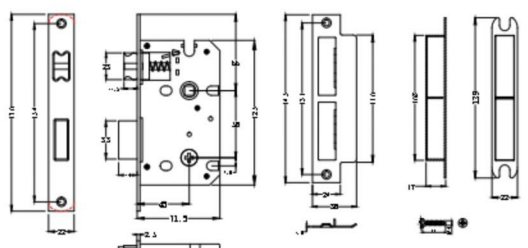

\* Side panel: optional square and rounded corners

### K5058

#### Ordinary lock body

##### Lock body parameter

- Door margin : 50mm
- Center distance : 58mm

##### Liner parameter

- Type : Square head
- Metal material : SUS304 SUS201
- Thickness : 2.5mm
- Width : 22mm
- Length : 168mm

##### Part parameter

- Oblique tongue : Zinc alloy
- Square tongue : Zinc alloy
- Square hole core : 8X8mm Iron
- Shell : Fingerprint-resistant electrolytic plate 1.2mm

##### Accessories

- Buckle plate : SUS304 SUS201
- Buckle box : PP
- Stainless steel screw

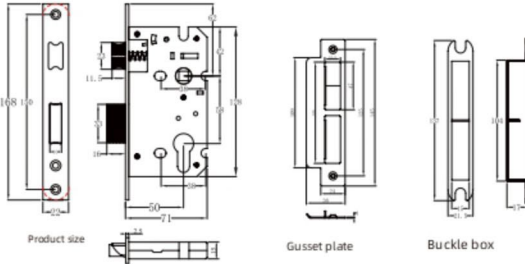
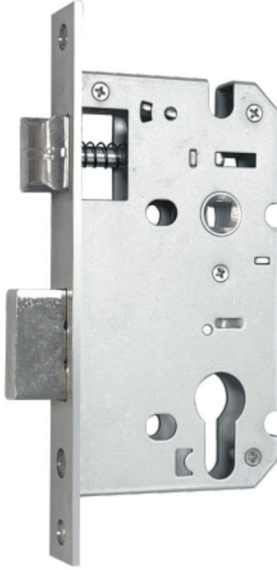

\* Side panel: optional square and rounded corners

### K5058

#### Anti insertion lock body

##### Lock body parameter

- Door margin : 50mm
- Center distance : 58mm

##### Liner parameter

- Type : Square head
- Metal material : SUS304 SUS201
- Thickness : 2.5mm
- Width : 22mm
- Length : 168mm

##### Part parameter

- Oblique tongue : SUS304
- Square tongue : SUS304
- Square hole core : 8X8mm Iron
- Shell : 430 stainless steel

##### Accessories

- Buckle plate : SUS304 SUS201
- Buckle box : PP
- Stainless steel screw

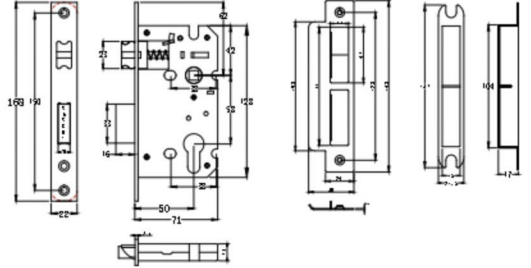

\* Side panel: optional square and rounded corners

### K5058

#### Mute lock body



##### Lock body parameter

- Door margin : 50mm
- Center distance : 58mm

##### Liner parameter

- Type : Square head
- Metal material : SUS304 SUS201
- Thickness : 2.5mm
- Width : 22mm
- Length : 168mm

##### Part parameter

- Oblique tongue : Zinc alloy
- Square tongue : Zinc alloy
- Square hole core : 8X8mm Iron
- Shell : Fingerprint-resistant electrolytic plate 1.2mm

##### Accessories

- Buckle plate : SUS304 SUS201
- Buckle box : PP
- Stainless steel screw

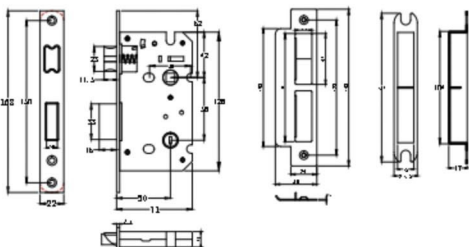

\* Side panel: optional square and rounded corners

### V5058

#### Mute lock body



##### Lock body parameter

- Door margin : 50mm
- Center distance : 58mm

##### Liner parameter

- Type : Square head
- Metal material : SUS304 SUS201
- Thickness : 2.5mm
- Width : 22mm
- Length : 168mm

##### Part parameter

- Oblique tongue : Zinc alloy
- Square tongue : Zinc alloy
- Square hole core : 8X8mm Iron
- Shell : Fingerprint-resistant electrolytic plate 1.2mm

##### Accessories

- Buckle plate : SUS304 SUS201
- Buckle box : PP
- Stainless steel screw

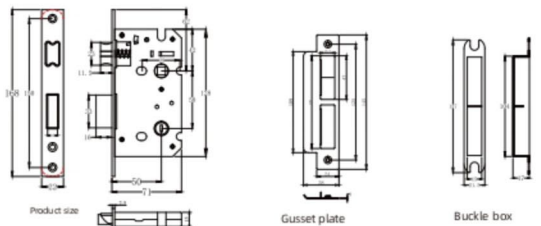

\* Side panel: optional square and rounded corners

### V5072

#### Anti insertion lock body

##### Lock body parameter

- Door margin : 50mm
- Center distance : 72mm

##### Liner parameter

- Type : Square head
- Metal material : SUS304 SUS201
- Thickness : 2.5mm
- Width : 22mm
- Length : 181mm

##### Part parameter

- Oblique tongue : Precision casting SUS304
- Square tongue : SUS304
- Square hole core : 8X8mm Stainless steel /Iron
- Shell : Fingerprint-resistant electrolytic plate 1.2/1.5mm

##### Accessories

- Buckle plate : SUS304 SUS201
- Buckle box : PP
- Stainless steel screw

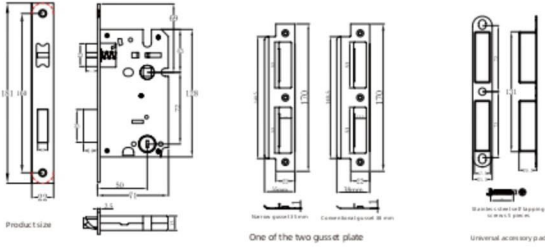

\* Side panel: optional square and rounded corners

### V5072

#### Common lock body

##### Lock body parameter

- Door margin : 50mm
- Center distance : 72mm

##### Liner parameter

- Type : Square head
- Metal material : SUS304 SUS201
- Thickness : 2.5mm
- Width : 22mm
- Length : 181mm

##### Part parameter

- Oblique tongue : Zinc alloy
- Square tongue : Zinc alloy
- Square hole core : 8X8mm Stainless steel /Iron
- Shell : Fingerprint-resistant electrolytic plate 1.2mm

##### Accessories

- Buckle plate : SUS304 SUS201
- Buckle box : PP
- Stainless steel screw

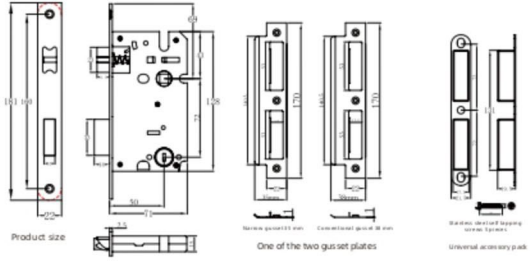

\* Side panel: optional square and rounded corners

### V5072

#### Mute lock body

##### Lock body parameter

- Door margin : 50mm
- Center distance : 72mm

##### Liner parameter

- Type : Round head
- Metal material : SUS304 SUS201
- Thickness : 3mm
- Width : 20/22/24mm
- Length : 175mm

##### Part parameter

- Oblique tongue : Zinc alloy
- Square tongue : Zinc alloy
- Square hole core : 8X8mm Stainless steel /Iron
- Shell : Fingerprint-resistant electrolytic plate 1.2/1.5mm

##### Accessories

- Buckle plate : SUS304 SUS201
- Buckle box : PP
- Stainless steel screw

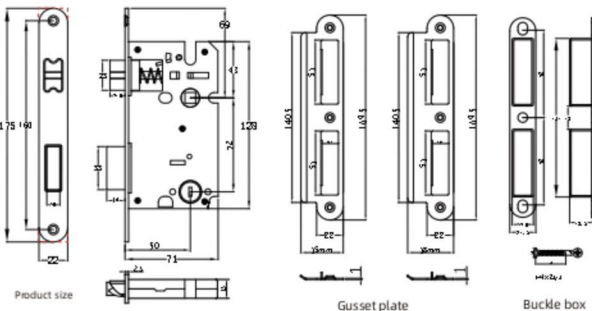

\* Side panel: optional square and rounded corners



### K5072B

#### Common lock body

##### Lock body parameter

- Door margin: 50mm
- Center distance: 72mm

##### Liner parameter

- Type: Square head
- Metal material: SUS304 SUS201
- Thickness: 2.5mm
- Width: 22mm
- Length: 181mm

##### Part parameter

- Oblique tongue: Precision casting SUS304
- Square tongue: SUS304
- Square hole core: 8X8mm Stainless steel /Iron
- Shell: Fingerprint-resistant electrolytic plate 1.2/1.5mm

##### Accessories

- Buckle plate: SUS304 SUS201
- Buckle box: PP
- Stainless steel screw

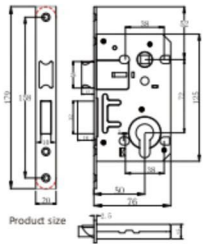

Product size

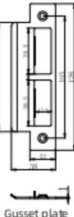

Gusset plate

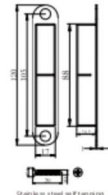

Stainless steel self-tapping screws 4 pieces  
Universal accessory pack

\* Side panel: optional square and rounded corners

### K5072B

#### Fireproof lock body

##### Lock body parameter

- Door margin: 50mm
- Center distance: 72mm

##### Liner parameter

- Type: Round head
- Metal material: SUS304 SUS201
- Thickness: 2.5mm
- Width: 20mm
- Length: 179mm

##### Part parameter

- Oblique tongue: SUS304
- Square tongue: SUS304
- Square hole core: 8X8mm Stainless steel /Iron
- Shell: Fingerprint-resistant electrolytic plate 1.2mm

##### Accessories

- Buckle plate: SUS304 SUS201
- Buckle box: PP
- Stainless steel screw

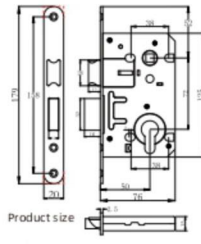

Product size

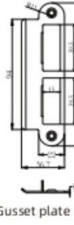

Gusset plate

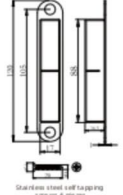

Stainless steel self-tapping screws 4 pieces  
Universal accessory pack

\* Side panel: optional square and rounded corners

### V5072B

#### Mute lock body

##### Lock body parameter

- Door margin: 50mm
- Center distance: 72mm

##### Liner parameter

- Type: Round head
- Metal material: SUS304 SUS201
- Thickness: 2.5mm
- Width: 20mm
- Length: 179mm

##### Part parameter

- Oblique tongue: Zinc alloy
- Square tongue: Zinc alloy
- Square hole core: 8X8mm Stainless steel /Iron
- Shell: Fingerprint-resistant electrolytic plate 1.2mm

##### Accessories

- Buckle plate: SUS304 SUS201
- Buckle box: PP
- Stainless steel screw

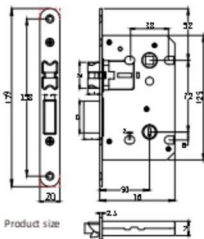

Product size

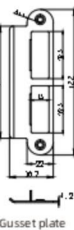

Gusset plate

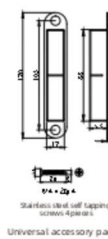

Stainless steel self-tapping screws 4 pieces  
Universal accessory pack

\* Side panel: optional square and rounded corners

### K5072B

#### Mute lock body

##### Lock body parameter

- Door margin: 50mm
- Center distance: 72mm

##### Liner parameter

- Type: Round head
- Metal material: SUS304 SUS201
- Thickness: 2.5mm
- Width: 20mm
- Length: 179mm

##### Part parameter

- Oblique tongue: Zinc alloy
- Square tongue: Zinc alloy
- Square hole core: 8X8mm Stainless steel /Iron
- Shell: Fingerprint-resistant electrolytic plate 1.2mm

##### Accessories

- Buckle plate: SUS304 SUS201
- Buckle box: PP
- Stainless steel screw

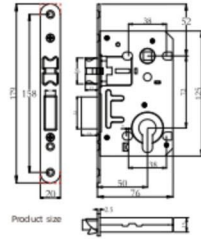

Product size

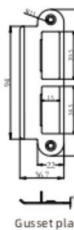

Gusset plate

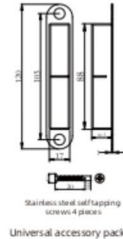

Stainless steel self-tapping screws 4 pieces  
Universal accessory pack

\* Side panel: optional square and rounded corners

### K5072W

#### Common lock body

##### Lock body parameter

- Door margin : 50mm
- Center distance : 72mm

##### Liner parameter

- Type : Square head
- Metal material : SUS304/SUS201
- Thickness : 2.5mm
- Width : 20/22/24mm
- Length : 200mm

##### Part parameter

- Oblique tongue : Zinc alloy
- Square tongue : Zinc alloy
- Square hole core : 8X8mm Stainless steel /Iron
- Shell : Fingerprint-resistant electrolytic plate 1.2/1.5mm

##### Accessories

- Buckle plate : SUS304 SUS201
- Buckle box : PP
- Stainless steel screw

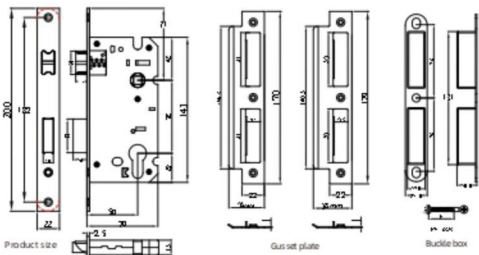

### K5072W

#### Mute lock body



##### Lock body parameter

- Door margin : 50mm
- Center distance : 72mm

##### Liner parameter

- Type : Round head
- Metal material : SUS304 SUS201
- Thickness : 2.5mm
- Width : 22mm
- Length : 198mm

##### Part parameter

- Oblique tongue : Zinc alloy
- Square tongue : Zinc alloy
- Square hole core : 8X8mm Stainless steel /Iron
- Shell : Fingerprint-resistant electrolytic plate 1.2/1.5mm

##### Accessories

- Buckle plate : SUS304 SUS201
- Buckle box : PP
- Stainless steel screw

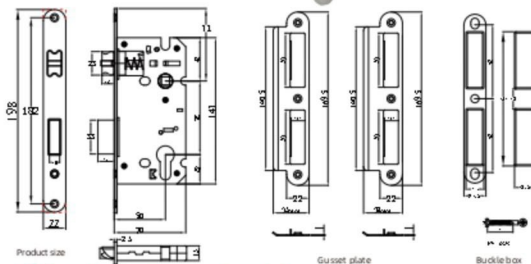

\* Side panel: optional square and rounded corners

\* Side panel: optional square and rounded corners



### D55

#### Unilateral tongue lock body

##### Lock body parameter

- Door margin : 55mm

##### Liner parameter

- Type : Square head
- Metal material : SUS304 SUS201
- Thickness : 3mm
- Width : 24mm
- Length : 138mm

##### Part parameter

- Square tongue : SUS304 Zinc alloy
- Shell : 1.2mm Stainless iron 430 Fingerprint-resistant electrolytic plate 1.2mm

##### Accessories

- Buckle plate : SUS304 SUS201
- Buckle box : PP
- Stainless steel screw

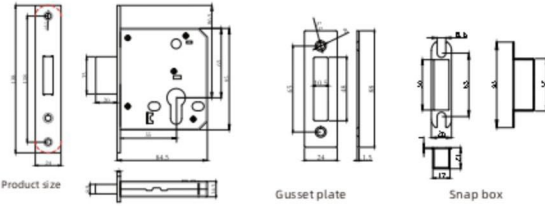

\* Side panel: optional square and rounded corners

### D55

#### Cylindrical lock body

##### Lock body parameter

- Door margin : 55mm

##### Liner parameter

- Type : Round head
- Metal material : SUS304 SUS201
- Thickness : 3mm
- Width : 24mm
- Length : 138mm

##### Part parameter

- Cylinder : SUS201
- Shell : Fingerprint-resistant electrolytic plate 1.2mm

##### Accessories

- Buckle plate : SUS304 SUS201
- Buckle box : PP
- Stainless steel screw

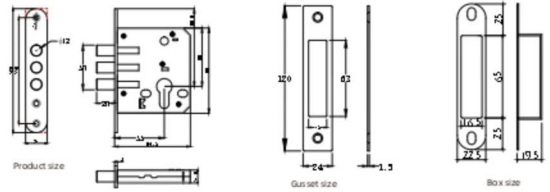

\* Side panel: optional square and rounded corners

### D55

#### Monoclinic tongue lock body

##### Lock body parameter

- Door margin : 55mm

##### Liner parameter

- Type : Square head
- Metal material : SUS304 SUS201
- Thickness : 3mm
- Width : 24mm
- Length : 138mm

##### Part parameter

- Square tongue : SUS304 Zinc alloy
- Square hole core : 8x8mm SUS304 Iron
- Shell : Fingerprint-resistant electrolytic plate 1.2mm

##### Accessories

- Buckle plate : SUS304 SUS201
- Buckle box : PP
- Stainless steel screw

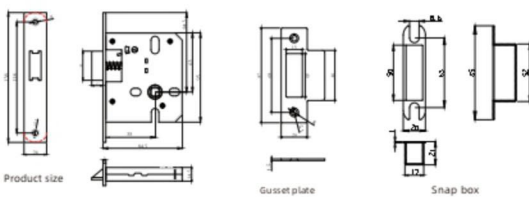

\* Side panel: optional square and rounded corners

### D55

#### Blade lock body

##### Lock body parameter

- Door margin : 55mm

##### Liner parameter

- Type : Square head
- Metal material : SUS304 SUS201
- Thickness : 3mm
- Width : 24mm
- Length : 138mm

##### Part parameter

- Square tongue : SUS304 Zinc alloy
- Shell : 1.2mm Stainless iron 430 Fingerprint-resistant electrolytic plate 1.2mm

##### Accessories

- Buckle plate : SUS304 SUS201
- Buckle box : PP
- Stainless steel screw

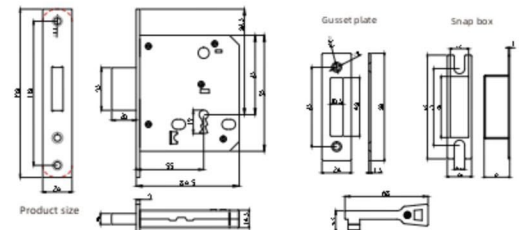

\* Side panel: optional square and rounded corners

### V5072

#### Double fast lock body

##### Lock body parameter

- Door margin : 50mm
- Center distance : 72mm

##### Liner parameter

- Type : Square head
- Metal material : SUS201
- Thickness : 2.5mm
- Width : 22mm
- Length : 175mm

##### Part parameter

- Oblique tongue : Zinc alloy
- Square tongue : Zinc alloy
- Square hole core : Iron
- Shell : Fingerprint-resistant electrolytic plate 1.2mm

##### Accessories

- Buckle plate : SUS201
- Buckle box : PP
- Stainless steel screw

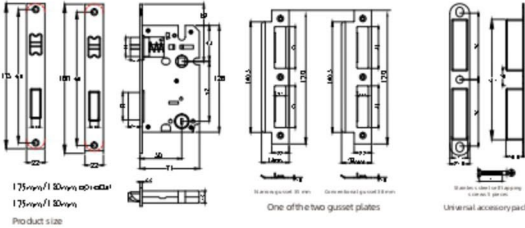

\* Side panel: optional square and rounded corners

### Z5072

#### Double fast lock body

##### Lock body parameter

- Door margin : 50mm
- Center distance : 72mm

##### Liner parameter

- Type : Square head
- Metal material : SUS304/SUS201
- Thickness : 3mm
- Width : 20/22/24mm
- Length : 235mm

##### Part parameter

- Oblique tongue : Zinc alloy
- Square tongue : Zinc alloy
- Square hole core : Iron
- Shell : Fingerprint-resistant electrolytic plate 1.2mm

##### Accessories

- Buckle plate : SUS304/SUS201
- Buckle box : PP
- Stainless steel screw

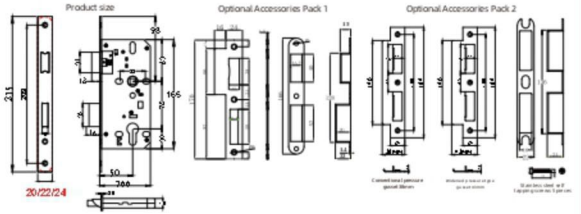
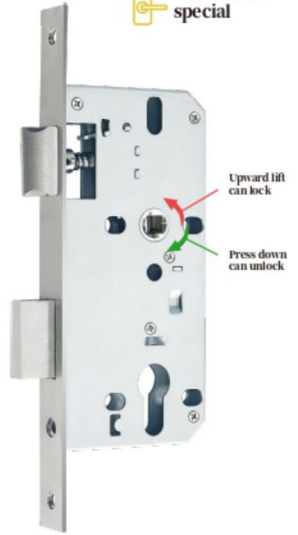

\* Side panel: optional square and rounded corners

### Z5572

#### Double fast lock body

##### Lock body parameter

- Door margin : 55mm
- Center distance : 72mm

##### Liner parameter

- Type : Square head
- Metal material : SUS304/SUS201
- Thickness : 3mm
- Width : 20/22/24mm
- Length : 235mm

##### Part parameter

- Oblique tongue : SUS304
- Square tongue : SUS304/SUS201
- Square hole core : Iron
- Shell : Fingerprint-resistant electrolytic plate 1.2mm

##### Accessories

- Buckle plate : SUS304/SUS201
- Buckle box : PP
- Stainless steel screw

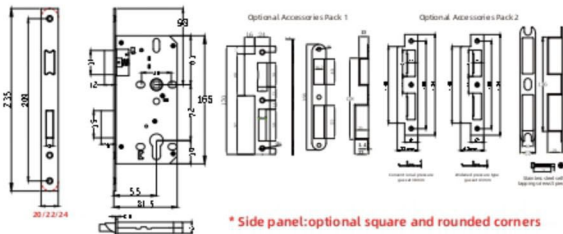

\* Side panel: optional square and rounded corners

### Z6072

#### Double fast lock body

##### Lock body parameter

- Door margin : 60mm
- Center distance : 72mm

##### Liner parameter

- Type : Square head
- Metal material : SUS304/SUS201
- Thickness : 3mm
- Width : 20/22/24mm
- Length : 235mm

##### Part parameter

- Oblique tongue : SUS304
- Square tongue : SUS304/SUS201
- Square hole core : Iron
- Shell : Fingerprint-resistant electrolytic plate 1.2mm

##### Accessories

- Buckle plate : SUS304/SUS201
- Buckle box : PP
- Stainless steel screw



\* Side panel: optional square and rounded corners

### Z3085

#### Double fast lock body

##### Lock body parameter

- Door margin : 30mm
- Center distance : 85mm

##### Liner parameter

- Type : Square head
- Metal material : SUS304 SUS201
- Thickness : 3mm
- Width : 22mm
- Length : 240mm

##### Part parameter

- Oblique tongue : SUS304
- Square tongue : SUS304 SUS201
- Square hole core : 8X8mm Iron
- Shell : Stainless steel casing

##### Accessories

- Buckle plate : SUS304 SUS201
- Buckle box : PP
- Stainless steel screw



Upward lift  
can lock

Pressdown  
can unlock

### Z3585

#### Double fast lock body

##### Lock body parameter

- Door margin : 35mm
- Center distance : 85mm

##### Liner parameter

- Type : Square head
- Metal material : SUS304 SUS201
- Thickness : 3mm
- Width : 22mm
- Length : 240mm

##### Part parameter

- Oblique tongue : SUS304
- Square tongue : SUS304 SUS201
- Square hole core : 8X8mm Iron
- Shell : Stainless steel casing

##### Accessories

- Buckle plate : SUS304 SUS201
- Buckle box : PP
- Stainless steel screw



Upward lift  
can lock

Pressdown  
can unlock

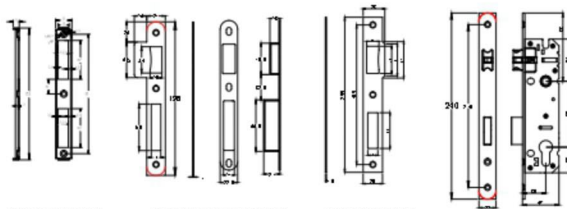

Profile view/buckle plate

Front view/buckle plate/buckle box

Top view/buckle plate

Product view

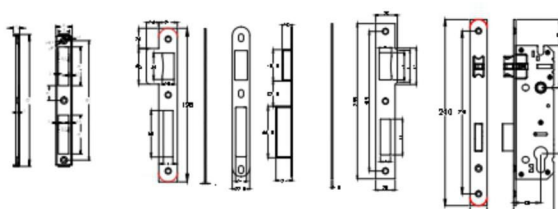

Profile view/buckle plate

Front view/buckle plate/buckle box

Top view/buckle plate

Product view

### Z4085

#### Double fast lock body

##### Lock body parameter

- Door margin : 40mm
- Center distance : 85mm

##### Liner parameter

- Type : Square head
- Metal material : SUS304 SUS201
- Thickness : 3mm
- Width : 22mm
- Length : 240mm

##### Part parameter

- Oblique tongue : SUS304
- Square tongue : SUS304 SUS201
- Square hole core : 8X8mm Iron
- Shell : Stainless steel casing

##### Accessories

- Buckle plate : SUS304 SUS201
- Buckle box : PP
- Stainless steel screw

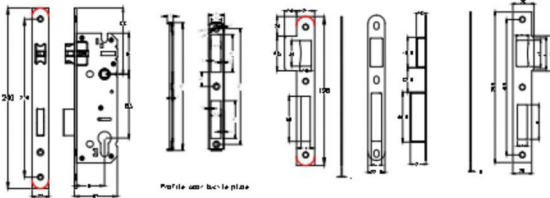
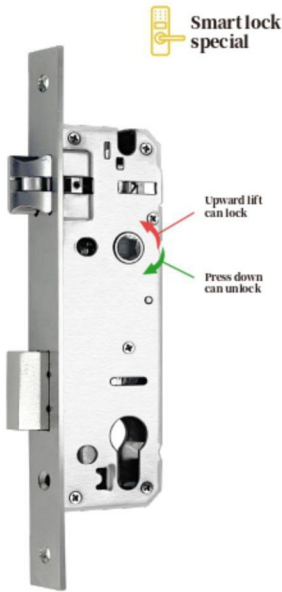

Product size

Gusset size

Accessory bag

\* Side panel: optional square and rounded corners

### Z4585

#### Double fast lock body

##### Lock body parameter

- Door margin : 45mm
- Center distance : 85mm

##### Liner parameter

- Type : Square head
- Metal material : SUS304 SUS201
- Thickness : 3mm
- Width : 22mm
- Length : 240mm

##### Part parameter

- Oblique tongue : SUS304
- Square tongue : SUS304 SUS201
- Square hole core : 8X8mm Iron
- Shell : Stainless steel casing

##### Accessories

- Buckle plate : SUS304 SUS201
- Buckle box : PP
- Stainless steel screw

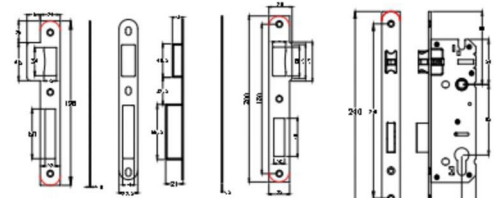
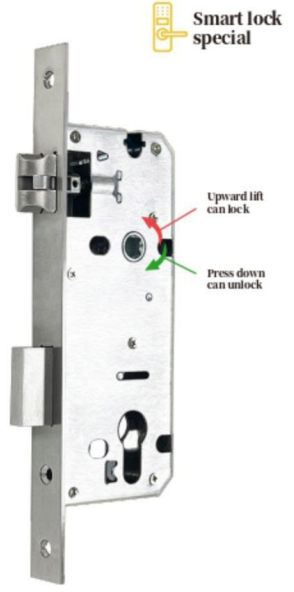

Product size

\* Side panel: optional square and rounded corners

### Z5085

#### Double fast lock body

##### Lock body parameter

- Door margin : 50mm
- Center distance : 85mm

##### Liner parameter

- Type : Square head
- Metal material : SUS304 SUS201
- Thickness : 3mm
- Width : 22mm
- Length : 240mm

##### Part parameter

- Oblique tongue : SUS304
- Square tongue : SUS304 SUS201
- Square hole core : Iron
- Shell : Fingerprint-resistant electrolytic plate 1.2mm

##### Accessories

- Buckle plate : SUS304 SUS201
- Buckle box : PP
- Stainless steel screw

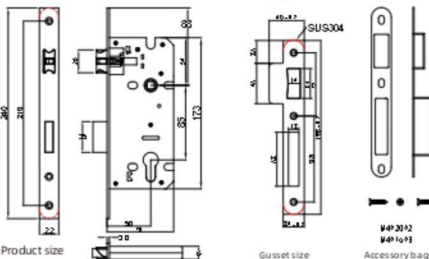
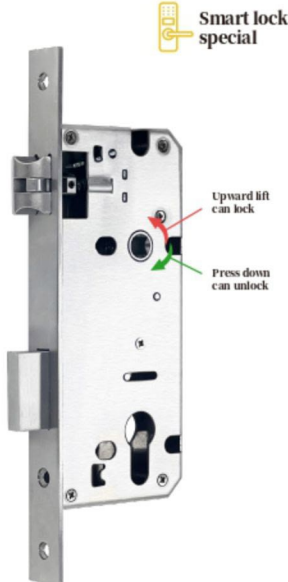

Product size

Gusset size

Accessory bag

\* Side panel: optional square and rounded corners

### Z6085

#### Double fast lock body

##### Lock body parameter

- Door margin : 60mm
- Center distance : 85mm

##### Liner parameter

- Type : Square head
- Metal material : SUS304 SUS201
- Thickness : 3mm
- Width : 22mm
- Length : 240mm

##### Part parameter

- Oblique tongue : SUS304
- Square tongue : SUS304 SUS201
- Square hole core : Iron

- Shell : Fingerprint-resistant electrolytic plate 1.2mm

##### Accessories

- Buckle plate : SUS304 SUS201
- Buckle box : PP
- Stainless steel screw

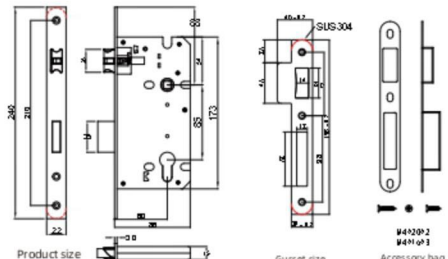

Product size

Gusset size

Accessory bag

\* Side panel: optional square and rounded corners

### G2085

#### Double hook lock body

##### Lock body parameter

- Door margin : 20mm
- Center distance : 85mm

##### Liner parameter

- Type : Square head
- Metal material : SUS201
- Thickness : 2.3mm
- Width : 22mm
- Length : 270mm

##### Part parameter

- Double hook : SUS304
- Square hole core : Iron
- Shell : 430 stainless steel

##### Accessories

- Buckle plate : SUS201
- Stainless steel screw

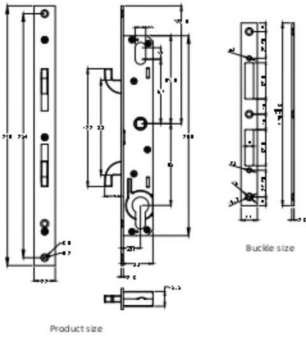

### G2585

#### Double hook lock body

##### Lock body parameter

- Door margin : 25mm
- Center distance : 85mm

##### Liner parameter

- Type : Square head
- Metal material : SUS201
- Thickness : 2.3mm
- Width : 22mm
- Length : 270mm

##### Part parameter

- Double hook : SUS304
- Square hole core : Iron
- Shell : 430 stainless steel

##### Accessories

- Buckle plate : SUS201
- Stainless steel screw

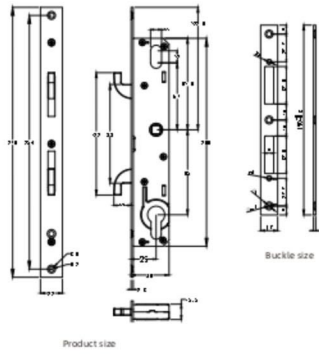

### G3085

#### Double hook lock body

##### Lock body parameter

- Door margin : 30mm
- Center distance : 85mm

##### Liner parameter

- Type : Square head
- Metal material : SUS201
- Thickness : 2.3mm
- Width : 22mm
- Length : 270mm

##### Part parameter

- Double hook : SUS304
- Square hole core : Iron
- Shell : 430 stainless steel

##### Accessories

- Buckle plate : SUS201
- Stainless steel screw

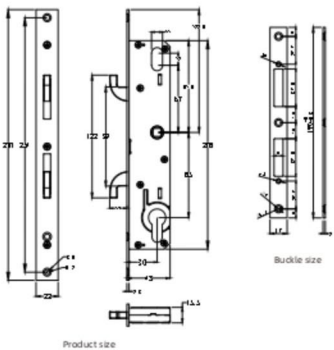

### G3585

#### Double hook lock body

##### Lock body parameter

- Door margin : 35mm
- Center distance : 85mm

##### Liner parameter

- Type : Square head
- Metal material : SUS201
- Thickness : 2.3mm
- Width : 22mm
- Length : 270mm

##### Part parameter

- Double hook : SUS304
- Square hole core : Iron
- Shell : 430 stainless steel

##### Accessories

- Buckle plate : SUS201
- Stainless steel screw

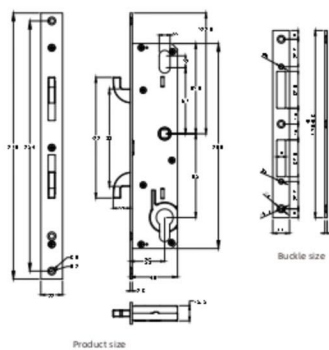

# Z5050 Double QuickAnti-insertion Lock Body (12 specifications)

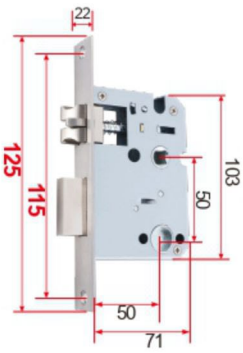

125×22mm



147×22mm



156×22mm

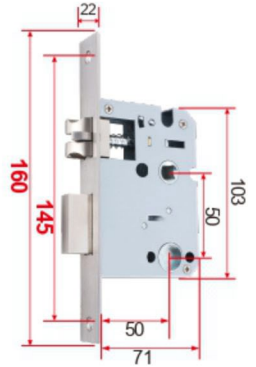

160×22mm

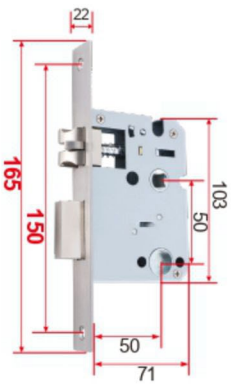

165×22mm



170×22mm



175×22mm

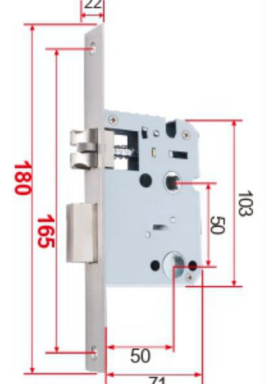

180×22mm

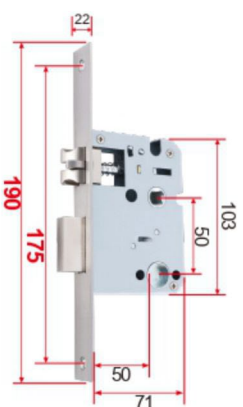

190×22mm



200×22mm



220×22mm

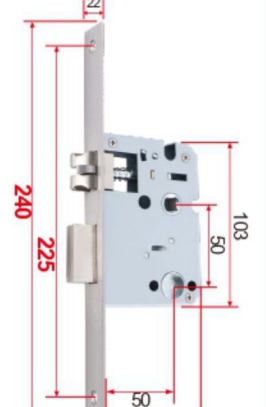

240×22mm

### CK5572F Magnetic lock body

#### Lock body parameter

- Door margin : 55mm
- Center distance : 72mm

#### Liner parameter

- Type : Round head
- Metal material : SUS304 / SUS201
- Thickness : 3mm
- Width : 20mm
- Length : 235mm

#### Part parameter

- Oblique tongue : Plastic
- Square hole core : Iron
- Shell : Galvanized plate

#### Accessories

- Buckle plate : SUS304 / SUS201
- Buckle box : PA66
- Stainless steel screw

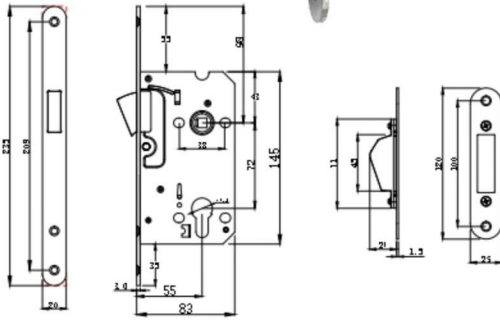

\* Side panel: optional square and rounded corners

### CV5572 Magnetic lock body

#### Lock body parameter

- Door margin : 55mm
- Center distance : 72mm

#### Liner parameter

- Type : Round head
- Metal material : SUS304 / SUS201
- Thickness : 3mm
- Width : 20mm
- Length : 235mm

#### Part parameter

- Oblique tongue : Plastic
- Square hole core : Iron
- Shell : Galvanized plate

#### Accessories

- Buckle plate : SUS304 / SUS201
- Buckle box : PA66
- Stainless steel screw

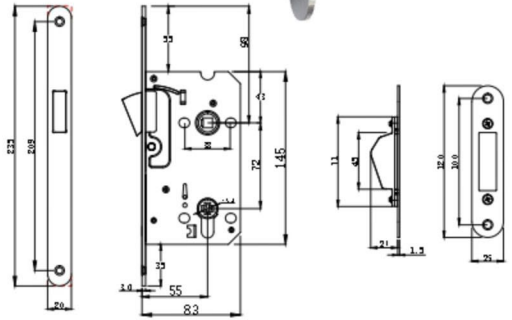

\* Side panel: optional square and rounded corners

### CK4558F Magnetic lock body

#### Lock body parameter

- Door margin : 45mm
- Center distance : 58mm

#### Liner parameter

- Type : Square head
- Metal material : SUS201
- Thickness : 2.5mm
- Width : 22mm
- Length : 170mm

#### Part parameter

- Oblique tongue : Non
- Square hole core : Iron
- Shell : Fingerprint-resistant electrolytic plate

#### Accessories

- Buckle plate : SUS201
- Buckle box : Non
- Stainless steel screw

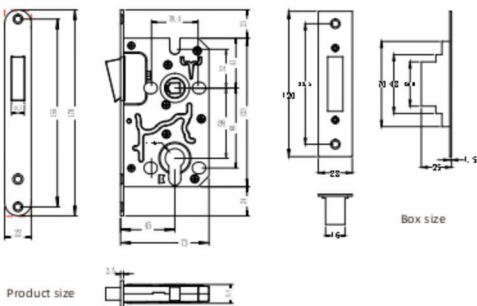

Product size

Box size

\* Side panel: optional square and rounded corners

### CK5572X Magnetic lock body

#### Lock body parameter

- Door margin : 55mm
- Center distance : 72mm

#### Liner parameter

- Type : Round head
- Metal material : SUS201
- Thickness : 3mm
- Width : 20mm
- Length : 235mm

#### Part parameter

- Square tongue : Non
- Square hole core : Iron
- Shell : Fingerprint-resistant electrolytic plate

#### Accessories

- Buckle plate : SUS201
- Buckle box : Non
- Stainless steel screw

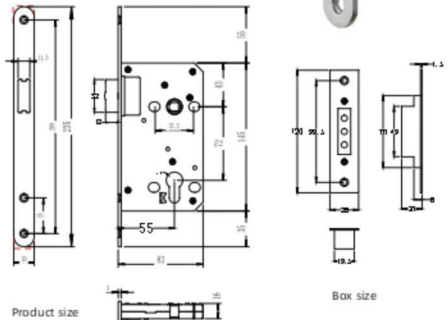

Product size

Box size

\* Side panel: optional square and rounded corners

### CK5085GT Mute lock body

#### Lock body parameter

- Door margin : 50mm
- Center distance : 85mm

#### Liner parameter

- Type : Round head
- Metal material : SUS201
- Thickness : 3mm
- Width : 18mm
- Length : 196mm

#### Part parameter

- Oblique tongue : Plastic
- Square hole core : Zinc alloy
- Shell : Gvanized plate

#### Accessories

- Buckle plate : SUS201
- Buckle box : PP
- Stainless steel screw



← Liner available in a variety of colors

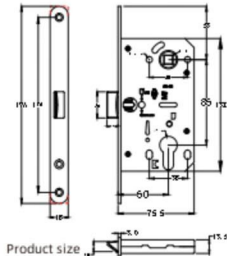

Product size

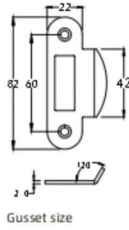

Gusset size

\* Side panel: optional square and rounded corners

### CK5085GT Magnetic lock body

#### Lock body parameter

- Door margin : 50mm
- Center distance : 85mm

#### Liner parameter

- Type : Round head
- Metal material : SUS201
- Thickness : 3mm
- Width : 18mm
- Length : 196mm

#### Part parameter

- Square tongue : Plastic
- Square hole core : Zinc alloy
- Shell : Gvanized plate

#### Accessories

- Buckle plate : SUS201
- Buckle box : PP
- Stainless steel screw



← Liner available in a variety of colors

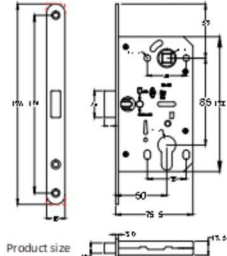

Product size

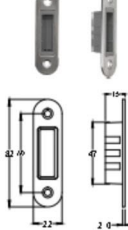

Gusset size

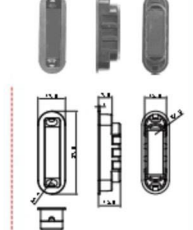

1F Snap box

2F Snap box

\* Side panel: optional square and rounded corners

### CY5085GT Mute lock body

#### Lock body parameter

- Door margin : 50mm
- Center distance : 85mm

#### Liner parameter

- Type : Round head
- Metal material : SUS201
- Thickness : 3mm
- Width : 18mm
- Length : 196mm

#### Part parameter

- Oblique tongue : Plastic
- Square hole core : Zinc alloy
- Shell : Gvanized plate

#### Accessories

- Buckle plate : SUS201
- Buckle box : PP
- Stainless steel screw



← Liner available in a variety of colors

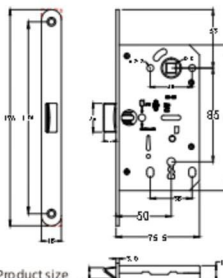

Product size

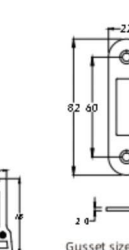

Gusset size

\* Side panel: optional square and rounded corners

### CY5085GT Magnetic lock body

#### Lock body parameter

- Door margin : 50mm
- Center distance : 85mm

#### Liner parameter

- Type : Round head
- Metal material : SUS201
- Thickness : 3mm
- Width : 18mm
- Length : 196mm

#### Part parameter

- Square tongue : Plastic
- Square hole core : Zinc alloy
- Shell : Gvanized plate

#### Accessories

- Buckle plate : SUS201
- Buckle box : PP
- Stainless steel screw



← Liner available in a variety of colors

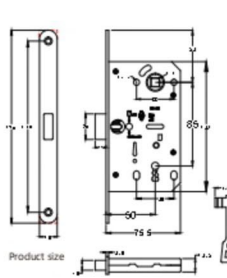
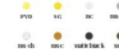

Product size

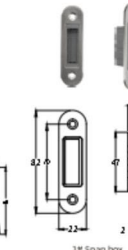

Gusset size

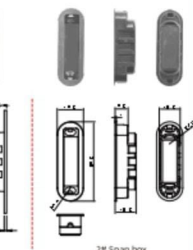

1F Snap box

2F Snap box

\* Side panel: optional square and rounded corners

### CW5096GT Mute lock body

#### Lock body parameter

- Door margin : 50mm
- Center distance : 96mm

#### Liner parameter

- Type : Round head
- Metal material : SUS201
- Thickness : 3mm
- Width : 18mm
- Length : 196mm

#### Part parameter

- Oblique tongue : Plastic
- Square hole core : Zinc alloy
- Shell : Galvanized plate

#### Accessories

- Buckle plate : SUS201
- Buckle box : PP
- Stainless steel screw



Liner available in a variety of colors

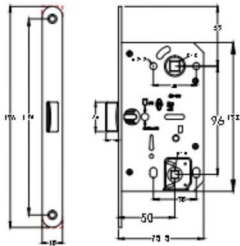

Product size

Gusset size

\* Side panel: optional square and rounded corners

### CW5096GT Magnetic lock body

#### Lock body parameter

- Door margin : 50mm
- Center distance : 96mm

#### Liner parameter

- Type : Round head
- Metal material : SUS201
- Thickness : 3mm
- Width : 18mm
- Length : 196mm

#### Part parameter

- Square tongue : Plastic
- Square hole core : Zinc alloy
- Shell : Galvanized plate

#### Accessories

- Buckle plate : SUS201
- Buckle box : PP
- Stainless steel screw



Liner available in a variety of colors

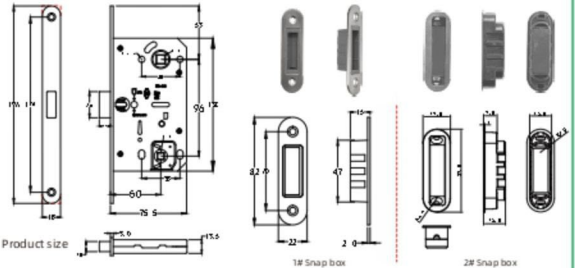

Product size

1# Snap box

2# Snap box

\* Side panel: optional square and rounded corners

### CK6085 Magnetic Trident tongue lock body

#### Lock body parameter

- Door margin : 60mm
- Center distance : 85mm

#### Liner parameter

- Type : Square head
- Metal material : SUS201
- Thickness : 3mm
- Width : 22mm
- Length : 240mm

#### Part parameter

- Magnetic tongue : Zinc alloy
- Square hole core : Iron
- Trident tongue : Zinc alloy
- Shell : Fingerprint-resistant electrolytic plate 1.2mm

#### Accessories

- Buckle plate : SUS201
- Buckle box : PP
- Stainless steel screw



Liner available in a variety of colors

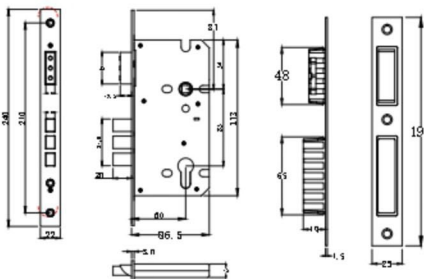

\* Side panel: optional square and rounded corners

### CK6085 Magnetic lock body

#### Lock body parameter

- Door margin : 60mm
- Center distance : 85mm

#### Liner parameter

- Type : Square head
- Metal material : SUS201
- Thickness : 3mm
- Width : 22mm
- Length : 240mm

#### Part parameter

- Magnetic tongue : Zinc alloy
- Square hole core : Iron
- Square tongue : Zinc alloy
- Shell : Fingerprint-resistant electrolytic plate 1.2mm

#### Accessories

- Buckle plate : SUS201
- Buckle box : PP
- Stainless steel screw



Liner available in a variety of colors

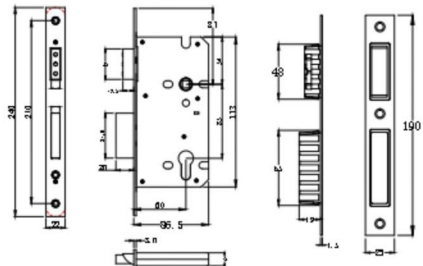

\* 衬板: 方角圆角可选 \* Side panel: optional square and rounded corners

### C60

#### Magnetic lock body

##### Lock body parameter

- Door margin : 60mm

##### Liner parameter

- Type: Round head
- Metal material : SUS201
- Thickness : 2.8mm
- Width : 22mm
- Length : 85mm

##### Part parameter

- Square tongue : Plastic
- Square hole core : Iron
- Shell : Stainless steel

##### Accessories

- Buckle box : PP
- Stainless steel screw

